

# licht.wissen 07

Light as a Factor in Health



Free Download at  
[www.all-about-light.org](http://www.all-about-light.org)





# Editorial

Light is vital for us all. It influences our hormone balance, regulates our sleep/wake rhythm and is involved in the production of important vitamins. It can help create a sense of wellbeing and has an impact on our mood. Light promotes health, affects bodily functions and shapes our state of mind.

Light is a factor in a healthy lifestyle – one that is best harnessed by activities outdoors where we are exposed to natural daylight. But protection from too much radiation is also required, of course, because an overdose can have negative effects. Caution is particularly advised in view of the environmental impacts of climate change. For time spent indoors, an intelligent mix of daylight and artificial lighting is recommended.

Where a person is ill or reliant on care, light becomes particularly important because it can promote the healing process. Medical light treatment, for example, is prescribed in cases of neonatal jaundice and certain skin disorders. For patients who are bedridden or in long-term hospital care, correct use of light provides valuable health support. For older people, especially residents of retirement or care homes, good lighting makes for a better day/night rhythm and heightened sense of wellbeing.

Correct lighting at work helps avoid accidents and, in the long term, contributes to a healthy life. So light plays an important part in occupational health and safety. This applies particularly to workplaces in the healthcare sector, which need to meet special requirements. From operating theatre and recovery room to examination and treatment room, different solutions are required for different room functions. That said, the design and provision of the right light for the occasion should be ensured by experts. Awareness of lighting technology research findings plays an important role here and a knowledge of normative requirements is essential. Interdisciplinary cooperation, e.g. between doctors, biologists, architects, lighting designers, engineers and researchers, is also an asset.

Optimal use of natural and artificial light is crucially important for us all because it has a direct impact on our health and particularly on the health of patients and staff in healthcare.

Ulrike Flach

Parliamentary State Secretary  
Federal Ministry of Health

[Cover] Modern LED luminaires provide optimal support for doctors and nurses conducting examinations and administering treatment.

[01] Coloured light in the CT room, supplemented by gentle changes of colour, has a positive impact on patients and helps lower anxiety levels.



Light and health  
Page 06



Changing society:  
Healthcare enters  
a new age  
Page 08



Good lighting aids  
recovery  
Page 10



Patient room  
lighting  
Page 12



Intermediate care  
unit lighting  
Page 14



Intensive care unit  
lighting  
Page 16



Operating theatre  
and ancillary room  
lighting  
Page 22



Medical supply units  
Page 26



## Lighting Specials

Biological impact of light on  
human beings Page 18



Energy efficiency and  
refurbishment Page 30



Standards and quality criteria  
for lighting Page 38





Examination and treatment room lighting  
Page 28



Ancillary room and outdoor area lighting  
Page 32



Rehabilitation lighting  
Page 36



Doctor's surgery lighting  
Page 42



Good lighting for nursing and retirement homes  
Page 48



Communal space lighting  
Page 50



Corridor and stairwell lighting  
Page 52



Resident room lighting  
Page 54



Imprint Page 63

Age and vision  
Page 46

LED, lighting management and daylight utilisation  
Page 56

Luminaires and their applications  
Page 58

Light sources  
Page 60





# Light and health

The impact of light and lighting on the human body is still often underestimated. Light is vital for many physiological and psychological processes. Quite apart from its central role in vision, it can, among other things, activate biological functions, promote concentration and raise our spirits.

In a hospital, as in a care home, good lighting is essential for both patients and staff. But the operator of the facility also has a keen interest in a functioning, efficient, high-quality lighting solution. Ultimately, the functionality of the lighting, the biological and emotional impact of the light and high energy efficiency are matters of major importance for everyone involved.

## Functional lighting for patients and staff

For patients and staff, high functionality is a crucial requirement for a lighting installation. Patients and care home residents require lighting that is tailored to their needs and individually adjustable, e.g. for reading in bed or for trips to the toilet at night. For medical staff, as well as for administrative, laboratory and service personnel, the light that is available needs to be appropriate for the visual tasks and activities performed. Particularly important here is the need for sufficiently high illuminance and good glare limitation. The colour rendering index of the lighting also needs to be right for the visual task. In diagnostics and surgery, in particular, a very good colour rendering index is essential to permit reliable recognition of subtle differences and details.

## Emotional impact of light

In the generally unpleasant context of a stay in hospital, a positive lighting atmosphere with a suitable balance of direct and indirect light can help raise spirits and make for better orientation in the room. In addition to that, a "clinically white" situation can be made less formal, less intimidating and more comfortable by the strategic use of coloured light or light that slowly changes colour.

## Biological impact on the human organism

Independent studies have established that there is a direct connection between daylight and our sense of wellbeing. Daylight has a positive effect on the human

organism and is responsible for important biological processes. Lack of daylight is often associated with sleep problems reported by patients and staff. Our sleep/wake rhythm (the circadian system) is controlled by the intensity and spectral composition – especially the blue content – of the light around us. Without daylight, the production of melatonin and cortisol, the hormones that basically regulate sleep/wake rhythm, is thrown out of kilter. In hospitals and retirement homes, long-stay patients and residents – i.e. persons who are already ill or frail – need as much natural or dynamic simulated daylight as possible. Lighting concepts that are in harmony with our internal clock promote patient and staff wellbeing.

## Sustainable for human health and the environment

According to a study conducted in 2009 by the Fraunhofer Institute in Karlsruhe, around 22% of the electricity consumed in hospitals goes on lighting. Given that the overall energy requirement is also high – due to 24-hour operation – managing it is a major environmental responsibility. Reducing carbon emissions is an important challenge for hospital operators as well as for the lighting concepts they adopt. That challenge is ideally met by modern lighting solutions, which have a long service life and low energy and maintenance requirements. The important thing is to ensure that the lighting concept is not just energy-efficient but also takes account of functional, biological and emotional human needs.

[02] "Light is life" - and it impacts directly on our mind and body. The quality of daylight and sunlight, in particular, can have a very positive effect on health and healing.

# Changing society: Healthcare enters a new age

The healthcare sector is in structural flux – not just in Germany but worldwide. In a society increasingly geared to comfort and wellness, hospitals are being transformed from a place for the sick and frail to a kind of "convalescence hotel".

This change in perception has implications for all areas of healthcare as well as for patients themselves. A sterile, uncomfortable atmosphere can only conflict with the aims of a hospital that seeks to offer comfortable, welcoming surroundings but at the same time has to ensure that its operations are energy and thus cost-efficient.

Hospitals today increasingly find themselves in competition for patients. Medical facilities alone do not offer enough distinguishing features; they are nowadays taken for granted. Whether a patient opts for one hospital or another is very often an instinctive choice. Ambience and sense of wellbeing play a major role here – and are particularly influenced by factors such as modern design and agreeable lighting. Warm tone lighting has a soothing effect, helps quell patient fears and thus makes for a greater sense of wellbeing in the ward. "Cold" high tech plays a less and less visible role in the day-to-day life of a hospital; the design of patient rooms is becoming more homely. Hospitals have recognised that the healing process can be promoted by a psychologically and physiologically supportive environment. With the right atmosphere and lighting, a hospital or care home can address the special needs of patients and staff. However, growing cost pressure on hos-

pital operators and shortages of medical personnel, especially doctors, are also appreciable factors today. Fewer and fewer beds are available to meet steadily rising demand. What is more, hospital stays are growing shorter and outpatient care is increasing. As a result of demographic change in our ageing society, this state of affairs will become increasingly significant in the future, because a balance needs to be maintained between quality and quantity of care on the one hand and the cost of delivering it on the other.

## Efficient and attractive

Lighting should be checked for its energy and maintenance requirements. In many instances, it makes sense to invest in new systems because they are more efficient power consumers and thus make for considerably lower energy costs. Longer maintenance intervals also reduce servicing requirements and similarly cut costs.

Older people have specific lighting requirements, especially those in need of a higher level of care. Avoidance of glare, the need for significantly more light and variable lighting control to support the body's "internal clock" are particularly important. Whatever the specific requirements, however, hospital or retirement

home lighting needs to address an extremely wide range of tasks. Diverse rooms for diverse activities present a host of lighting requirements.

[04] The modern hospital: medical facilities are supplemented by waiting areas, cafés and shops – with a great deal of importance attached to design, functionality and good lighting quality.

[05] Patient rooms are designed to ever-higher standards. Here, lighting needs to be functional but also attractive.



## Coloured light and its impact on human beings

Soothing effect [03]: The right lighting atmosphere can soothe and relax patients, especially in stress situations, e.g. before examinations, surgery or notification of examination results. Harmonious lighting has a positive effect on patients and can influence their condition. Light that changes colour and intensity generates an atmosphere that can have a variety of positive impacts on patients. Modern touchscreen control enables the colour atmosphere to be tuned to any situation. Yellow light soothes, green light promotes a sense of security and creativity and violet light, used sparingly, has a stimulating effect. Coloured lighting in a CT room, for instance, can allay fears, promote wellbeing and at the same time lower drop-out rates or help ensure that scans are successfully performed first time. Coloured light can also convey a special message, enhancing and personalising the image of the establishment.





04



05



06



07



08

# Good lighting aids recovery

Lighting has a considerable influence on our sense of wellbeing. Light is not only vital for vision; it also affects our emotions and other biological processes such as our sleep/wake rhythm.

A direct connection between daylight, health and patient wellbeing has been established in a number of independent studies. It is mainly due to light's impact on our sleep/wake rhythm, which has a wide-ranging influence on our emotional and physical welfare. Biologically effective lighting brings the dynamism of daylight indoors and can synchronise patients' internal clock with the outside world despite their being unable or rarely able to leave the building. More information on this subject is found in the chapter "Biological impact of light on human beings" (page 18 ff).

## Harnessing light to promote wellbeing

Coloured light and light that changes colour are particularly good for addressing patients' emotions. Together with a welcoming room atmosphere, they help make the surroundings less clinical and more homely for patients and visitors. Where

agreeable, soothing lighting is provided, patients and staff feel better and treatments are administered more efficiently and successfully.

## Diagnosis, treatment, recovery

To work efficiently, nurses and doctors need bright, functional light. Optimal illumination of the work area helps ensure clear diagnosis and targeted treatment. Clearly structured, illuminated rooms also give patients a sense that they are safe, competent hands. Treatment rooms require ergonomically correct examination lighting but also agreeable room lighting in which patients can relax and feel comfortable. However, patients spend most of the time in hospital in their room, where lighting can help promote recovery in a variety of ways, from delivering biologically effective light to providing functional light for reading. More information on patient room lighting is found on page 12.

[06] Everything under one roof: from operating theatre to patient room, to cafeteria – good lighting is required everywhere.

[07, 08] First impressions count! Brightly and agreeably lit approach roads, facades, entrance areas and foyers radiate competence and dependability.

[09] Surgical lighting needs to be bright, shadow-free and infinitely adjustable. It also needs a very good colour rendering index.

[10] Patient room lighting needs to be variable and adjustable to meet the needs of both nursing staff and patients.



09



10

## Patient room lighting

With homely, well furnished patient rooms, a service-oriented hospital can make a positive lasting impression. Good – and above all variable – lighting is needed here to help it compete for "clients" from a position of strength.

Indirect lighting delivering at least 100 lux illuminance and warm-white light is particularly recommended for an agreeable, homely atmosphere in patient rooms. Indirect light makes a room look bigger, has a soothing effect and is thus generally preferred by patients. To rule out the risk of direct glare for bed-ridden patients, DIN 5035-3 requires that the average luminance of luminaires visible from the bed should be limited to 1,000 candela per square metre. It also stipulates that the brightness produced by the indirect lighting at the ceiling should not exceed 500 candela per square metre.

Reading lights – which are required for every hospital bed – need to deliver a minimum of 300 lux on the reading plane and should be individually switched so that

others sharing the room are not disturbed. For further details and for information about DIN 5035-3 requirements, see the grey box on the right. Where people may need to find their way at night in unfamiliar surroundings, orientation lighting is essential. Here, care needs to be taken to ensure that sleeping patients are not disturbed. One good solution is wide-angled LED lighting mounted below bed level and at doors. Night lighting is also required. This should deliver 5 lux illuminance on a plane 0.85m above floor level so that sufficient light is available for a nurse to survey the room and perform simple tasks without unduly disturbing patients.

According to DIN EN 12464-1 and DIN 5035-3, illuminance on the examination plane needs to be 300 lux for nursing tasks

and simple examinations. Uniformity – the ratio of maximum to average illuminance – should be no less than 1:2. Examinations and treatments or emergencies require a minimum of 1,000 lux. Examination lighting needs to be glare-free for staff.

Owing to the variable requirements that need to be met in patient rooms, all luminaires need to be separately switched. The right lighting situation should always be easy to select. A lighting control system enables the different lighting scenarios to be conveniently stored and activated as required at the push of a button. Apart from the functional lighting essential for hospital operations, many hospitals today also install biologically effective lighting. This is lighting that produces adapts brightness and light

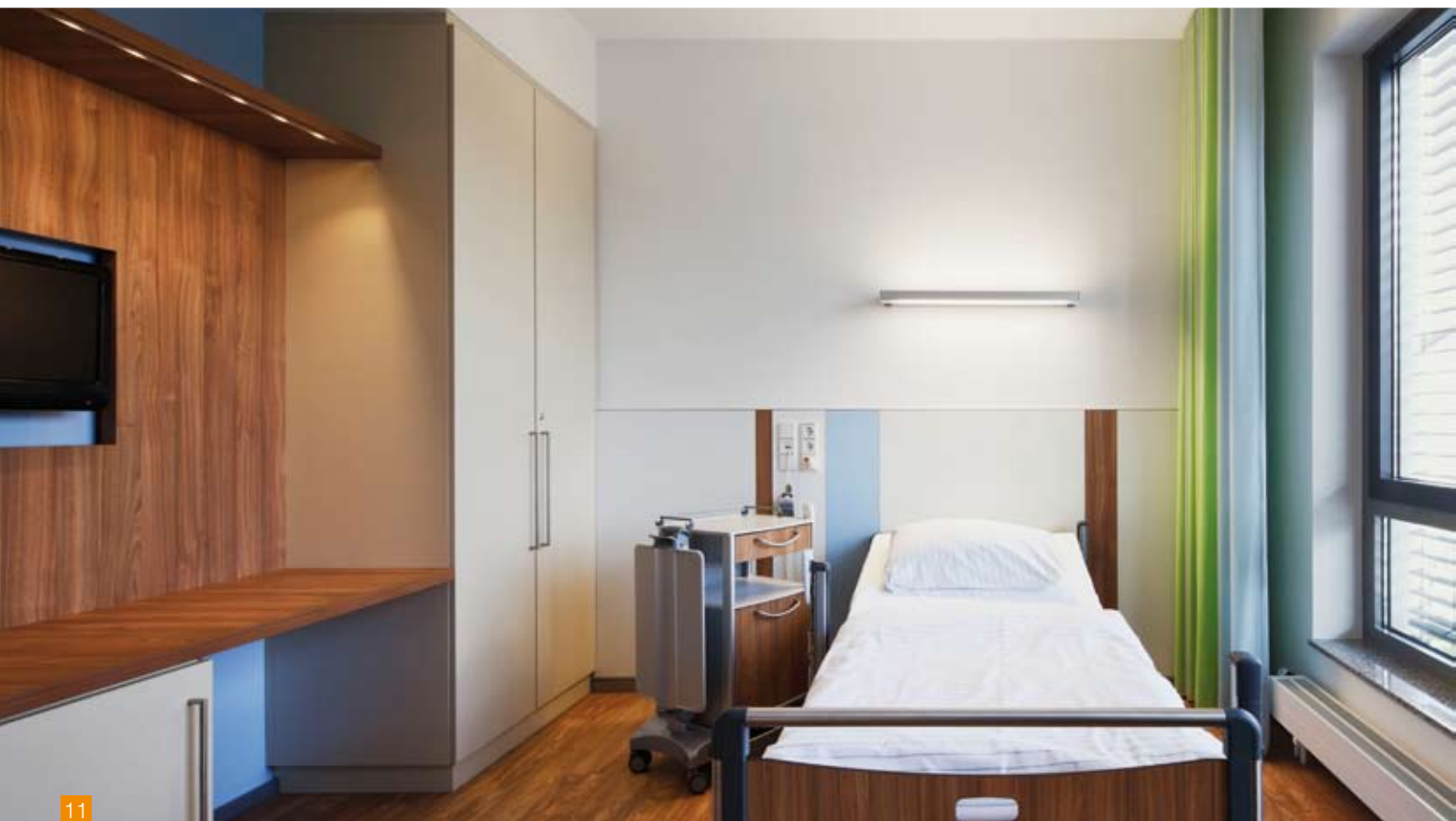

colour to the human circadian rhythm. It thus supports patients' natural active and resting phases, ensures a good night's sleep and generally promotes a swifter recovery.

More information about biologically effective lighting is found on pages 18 to 21.

[11, 12] Bright, colourful, attractive rooms help raise patients' spirits in the dull daily routine of hospital life. Modern lighting and supply systems are increasingly designed to be inconspicuous and homely. They thus contribute to the atmosphere that influences a patient's choice of hospital.

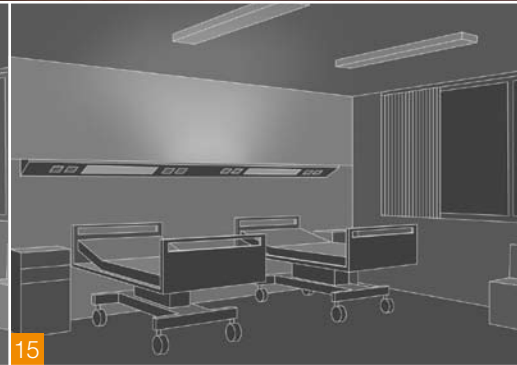
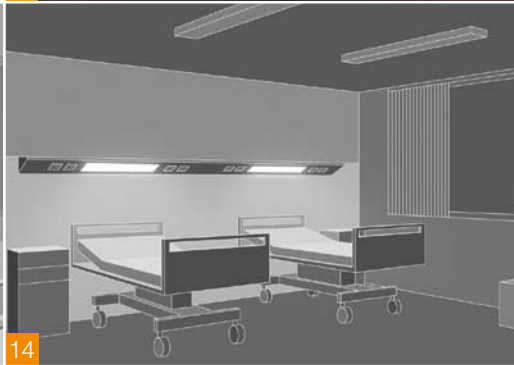

Task or activity area (values according to DIN EN 12464-1 and DIN 5035-3)

	$\bar{E}_{m, Lux}$	UGR <sub>L</sub>	U <sub>o</sub>	R <sub>a</sub>
General lighting	100	19	0.4	80
Reading lighting	300	19	0.7	80
Simple examination	300	19	0.6	80
Examination and treatment	1,000	19	0.7	90
Night lighting	5	-	-	80
Bathrooms and toilets for patients	200	22	0.4	80

## Glare limitation and reading light requirements at patients' beds

Glare-free reading in bed [13 - 15]: 300 lux illuminance is required for a patient reading in bed. DIN 5035-3 defines the reading plane as a plane 300 mm high and 900 mm wide inclined at 75° to the horizontal. The mid-point of the plane is 1,100 mm above floor level and 800 mm from the head of the bed (see also Fig. 67 in the chapter on standards on page 38). In the case of individually adjustable reading lights, it is sufficient if 300 lux is achieved over any 300 x 300 mm reading area within the reading plane.

To prevent direct glare for the patient in bed, the luminous surfaces of any luminaire visible from the bed need to be limited to 1,000 cd/m<sup>2</sup> luminance within the patient's direct field of vision. Direct field of vision is defined as all points that can be perceived by a person reclining in a horizontal position with head turned at any angle. The maximum permissible brightness of the ceiling in the patient's field of vision is 500 cd/m<sup>2</sup>.

$\bar{E}_{m, Lux}$ : illuminance, UGR<sub>L</sub>: glare, U<sub>o</sub>: uniformity, R<sub>a</sub>: colour rendering



16



17



18

# Intermediate care unit lighting

Structural reform of the healthcare sector led years ago to a new care category known as intermediate care. In terms of level of care, an intermediate care unit is a facility between a regular ward and an intensive care unit and requires a flexible high-performance lighting solution.

The level of monitoring required by patients in an intermediate care unit (IMCU) is significantly higher than in a regular ward but not as high as in an intensive care unit. As far as lighting is concerned, the standard requirements are basically the same as for a regular ward: DIN 5035 requires 300 lux on the treatment plane for simple examinations and 1,000 lux for more extensive ones. To meet the special requirements of the more intensive care provided, however, higher illuminance is recommended for certain lighting scenarios, e.g. night lighting. The standard requires 5 – 20 lux but the higher value should definitely be selected here to ensure better patient observation. A higher colour rendering index is also very important for intermediate care and supervision because life threatening emergencies need to be anticipated at all times.

If VDU monitoring is required, reflected glare needs to be kept to a minimum and the lighting level lowered, if necessary, for better screen contrast.

In comparison to regular care rooms, the more complex equipment of an IMCU requires medical supply units with more supply line outlets. They also need to be designed for more intensive use. Furthermore, lighting conditions need to be ergonomically correct for all medical equipment. The key requirement here is that the lighting concept should take full account of the instruments and devices present, some of which are highly sensitive.

## Special patient needs

Patients in intermediate care are confined to bed. Care should be taken to ensure that luminaires do not hang directly over beds. An adjustable-intensity reading light positioned correctly at the bed is particularly important here to help make the patient's stay in the IMCU as comfortable

as possible (see also the grey box on reading lighting on page 13).

## Biologically effective light

Patient welfare can also be promoted in intermediate care by biologically effective lighting. This uses dynamic changes in intensity and light colour (especially the blue content of light) to impact positively on a patient's sleep/wake rhythm (circadian system). The production of melatonin and cortisol – the hormones mainly responsible for controlling our sleep/wake rhythm – is thus stimulated and stopped at the appropriate times of day.

Biological impact aside, coloured light and dynamic colour sequencing can also have an emotional appeal. Patients today do not select a hospital solely on the basis of treatment facilities; their choice is partly based on atmosphere and the appearance of rooms. The right lighting can play an important role in shaping the "client's" decision.



## Direct and indirect lighting

Indirect lighting [19] is particularly suitable for creating an agreeable, homely atmosphere. Indirect light makes a room look larger and has a soothing effect on patients. Gentle – and above all glare-free – indirect light delivering 20 lux illuminance is also recommended for night-time observation of patients in intermediate care. The indirect lighting is supplemented by direct lighting, which performs additional functions and should be separately switched so it can be activated as required. This may be for reading – for which a minimum of 300 lux is required – or for treatments and examinations, which call for bright functional lighting. Here, a minimum of 1,000 lux illuminance and a colour rendering index of at least  $R_a 90$  are required. Further information on illuminance requirements is provided in the sections on intensive care units (pages 16 17) and patient rooms (pages 12-13).

[16] Multi-functional wall luminaires provide agreeable, separately switched direct or indirect lighting as well as night lighting.

[17] Variable lighting for intermediate care is provided by a combination of recessed ceiling luminaires and separately switched and dimmable recessed wall luminaires as ceiling floods.

[18] Horizontal supply units offer a wide range of possibilities for direct and indirect lighting with integrated reading and night lighting.

# Intensive care unit lighting

In rooms used for intensive care, the primary purpose of lighting is to support the treatment and monitoring of severely ill patients. First and foremost it needs to be functional, but it should still permit a homely lighting atmosphere to calm patients and help them make a swift recovery.

The many different tasks, procedures and activities performed in an intensive care unit (ICU) require a multi-level lighting system that permits separate and flexible switching and dimming. General lighting is normally provided by an indirect lighting solution designed to produce 100 lux illuminance (for compliance with DIN 5035-3) throughout the room and at the same time create a comfortable atmosphere. Direct lighting at beds supports the simple examinations performed by nursing staff and provides reading light for patients. For more complex examinations or emergency treatment, stationary examination and treatment lighting delivering 1,000 lux illuminance and with a colour rendering index of at least  $R_a$  90 is additionally required.

## Sleep despite monitoring

Constant monitoring is provided for the patient's benefit and can save lives. However, sleep and its positive effect on patient recovery should not be neglected. For this reason, observation and night-time supervision lighting should produce no more than 20 lux illuminance. Any adjoining rooms with an observation window require lighting that can be adjusted to the low level of illuminance in the intensive care room. To ensure that the patient is not disturbed, that light needs to be shielded and glare-free. Care must also be taken to avoid visual interference due to reflections on the glass.

However, intensive care is not only delivered in an intensive care unit. Rooms on regular wards are often furnished and equipped so they can be used for intensive care procedures and constant patient monitoring. In an emergency, they then become a convenient – but normally temporary – facility for vital sign monitoring. Like the equipment, the lighting for such rooms needs to be adaptable to cater for these additional tasks. A very good colour rendering index ( $R_a$  90) is one of the requirements. Patients can then be spared the discomfort and stress of being transferred to the intensive care unit. The

actual ICU is generally attached to the surgical wing of the hospital and is equipped with highly specialised medical machinery and systems.

## Medical supply units with lighting

General lighting, examination lighting and other lighting functions can be integrated into horizontal supply units. To produce the 1,000 lux needed for examinations and treatment, the light can be supplemented by luminaires on the ceiling (e.g. clean room luminaires).

For infant care rooms, the illuminance produced by the general lighting should be doubled (200 lux) and a warm-white colour tone is recommended. Where infants are also kept for observation, a neutral-white light colour should be selected so that any discolouration of the skin can be correctly recognised.

## Dynamic lighting helps patients

Dynamic lighting control is another component of modern lighting solutions for intensive care units. It adjusts the level of lighting to the current daylight situation and simulates the changing light colour and intensity of natural daylight during the course of the day. This "natural progression" gives daylight-starved patients a sense of normality and familiarity. Wellbeing is promoted and the recovery process positively influenced. In an emergency, however, standard-compliant neutral white examination lighting with a good colour rendering index needs to be instantly accessible at the push of a button.

[20] A supplementary examination light supports doctors and nurses in their work.

[21] In intensive care, a great deal of importance is attached not only to functional lighting but also to biologically effective light. This simulates the changing light colour and intensity of natural daylight during the course of the day.

[23] Functionality and quality are key requirements for intensive care unit lighting. Patient safety has top priority here.





20



21



22



23

## Four lighting situations

At least four lighting situations [22] need to be instantly accessible in any room where intensive care is provided: general lighting for background brightness, 300 lux illuminance for simple reading tasks and examinations, 1,000 lux for emergency procedures and max. 20 lux night/observation lighting that does not disturbing patients who are asleep.

Task of activity area (values according to DIN EN 12464-1 and DIN 5035-3)	$\bar{E}_m$ Lux	UGR <sub>L</sub>	U <sub>o</sub>	R <sub>a</sub>
General lighting	100	19	0.4	90
Simple examinations	300	19	0.6	90
Examination and treatment	1,000	19	0.7	90
Night watch	20	19	-	90

$\bar{E}_m$ : lux; illuminance, UGR<sub>L</sub>: glare, U<sub>o</sub>: uniformity, R<sub>a</sub>: colour rendering

# Biological impact of light on human beings

Throughout evolution, light has been vital for all life on Earth. From photosynthesis in plants to hormone production in the human body, many biological processes hinge crucially on exposure to light. Awareness of that fact is increasingly influencing indoor lighting.

Most of the information we receive about our environment is visual. Light is a key requirement for that. But light does far more for the human body than just permit vision. It controls many biological processes and, in the natural progression of daylight, acts as a pacemaker for the human sleep/wake rhythm.

## Circadian rhythm

Our circadian rhythm – our 24-hour biological clock – is significantly governed by the hormone melatonin. Produced in the pineal gland in the centre of the brain, melatonin regulates many organic processes via signals defined by its concentration in the blood. Our capacity for action is directly related to the amount of melatonin in circulation. If the level is high, we start to feel tired. A high level of cortisol, on the other hand, provides the basis for our waking phases – the phases in which we can be active and productive. Melatonin and cortisol production is directly controlled by the amount of light falling on the retina,

regardless of the visual process. A lot of light – especially in the short-wave spectral range – causes the cortisol level to rise and suppresses production of melatonin. That is why we wake up when it is light and feel tired when it gets dark. Fig. 31 on the double page overleaf shows the level of cortisol and melatonin in our body and how it affects us during the course of the day.

By stabilising hospital patients' and retirement or care home residents' circadian rhythm, biologically effective light can set in motion a positive spiral that significantly improves cognitive abilities and emotional state by ensuring a good night's sleep and an active day. Long-term studies in care homes – where lighting requirements are particularly high – show that residents are noticeably more agile, independent and communicative if they frequently spend time in rooms with biologically effective lighting.



### Utilising daylight

Natural daylight is particularly important in healthcare establishments. Because of mobility problems, patients and retirement or care home residents spend most of their time indoors. Windows, light shafts and daylight systems should, where possible, be used to maximise incident daylight without causing glare or an excessive build-up of heat. If not enough daylight is available, artificial lighting needs to be used to ensure a sufficiently high level of brightness in rooms. Light sensors and modern lighting management systems help adjust the lighting and make sure that enough light is available where it is needed, e.g. in parts of a room that are not near a window.

### Strategic use of artificial lighting

Modern lighting concepts use light specifically to influence biological processes in the human body. Particularly bright light, for example, is provided to heighten alertness during waking hours or dynamic light to convey a sense of day and night despite the absence of daylight.

### Taking a leaf from nature

Biologically effective light works by modulating illuminance and light colour. Although natural daylight reaches thousands of lux, 500 to 1,500 lux is enough

to produce a biological effect indoors. It is important, however, to replicate certain lighting conditions that are found outdoors: the light source should be planar and light should enter the eye from above and from the front so that it reaches the sensitive receptors in the lower part of the retina. The light should also have a colour temperature similar to daylight. Imitating daylight means recreating not only its full chromatic spectrum but also its dynamism and variability.

### Light colour and illuminance

Light colour and illuminance play an important role in the design of biologically effecting lighting indoors. Light colour is expressed as a colour temperature in kelvin (K) and ranges from warm white (< 3,300 K) to daylight white (> 5,300 K). The blue short-wave content of light, with a colour temperature greater than 5,300 K, has a particularly activating effect on the human body during the day. New fluorescent lamps can extend the short-wave range up to 17,000 K. For biological activation, chronobiologists recommend brief exposure (preferably in the morning) to an illuminance well above that required by standards. In the evening, warm light colours less than 3,300 K and a significantly lower lighting level should be used to prepare the body slowly for night. See also Fig. 29 on the following page.

[24] The best start to the day is achieved with light that switches from neutral-white to daylight-white during the morning and, at the same time, steadily increases in intensity.

[25] At midday, brightness and a cold-white light colour are required to achieve an activating effect.

[26] Warm light colours and a lower lighting level make for a relaxing evening

[27] Darkness helps ensure a peaceful night. Orientation lighting gives a sense of security.

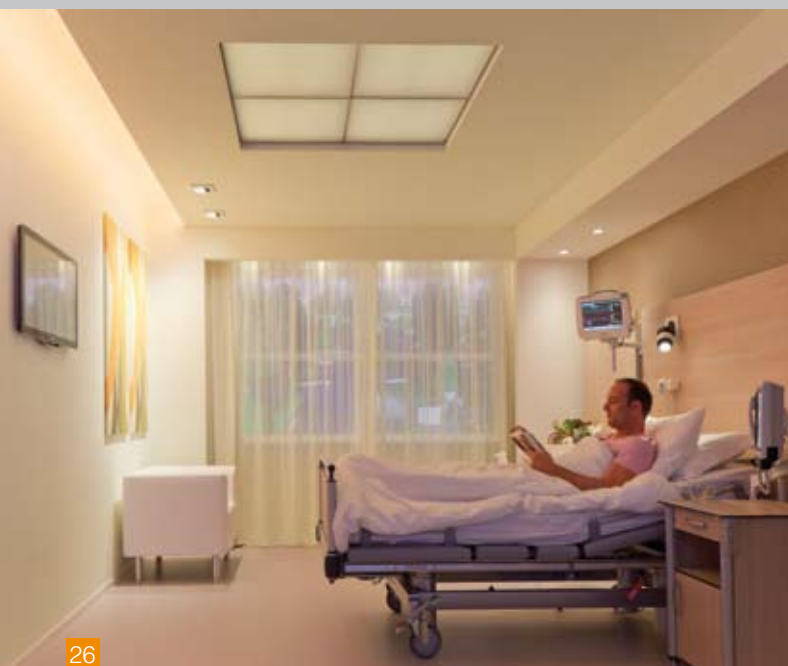

26

27



28

### Older people need more light

A healthy day/night rhythm depends crucially on the stimulating effect of light falling on the retina. As we get older, however, the stimuli are often weakened by processes that start around the age of 40 and affect visual acuity, adaptation and sensitivity to glare. The lens of the human eye becomes more opaque with age, letting less light through to the retina. This process not only impairs visual performance; it also means that less short-wave light reaches the receptors in the retina that influence cortisol production. Unless brightness is raised, an opaque lens lets less light enter the eye and less cortisol is produced in the body. This results in a higher concentration of melatonin, which signals a rest phase. The consequences are reduced activity and productivity. In

the long term, a general listlessness is observed, which can develop into depression. Partly as a result of restricted mobility and the consequent lack of exposure to daylight, many older people suffer from day/night rhythm disturbance; they become restless at night and feel tired during the day. So dynamic lighting concepts are needed to imitate the day/night rhythm and, in conjunction with a generally higher level of illuminance, restore a rhythm of active daytime phases and regenerative night-time phases. Further information on the subject of "Age and Vision" is found on page 46ff.

### Lighting design parameters

Like its role model in nature, artificial lighting can have a positive impact on human beings.

The most important parameters are:

- high illuminance – this intensifies the biological impact
- planarity – the light should be emitted over a large luminous area (like the sky)
- direction of light – effective circadian light needs to enter the eye from the front and from above (see Fig. 32)
- colour temperature – this needs to be similar to daylight and, above all, contain the same spectrum of biologically effective blue light
- dynamism – colour temperature and illuminance need to be adjusted dynamically to imitate the changes in daylight during the day

[28, 30] Biologically effective light helps older people develop a balanced day/night rhythm.

[29] From a biological viewpoint, warm white light has a relaxing effect on the human organism whereas daylight white makes us more active.

### Activity and relaxation

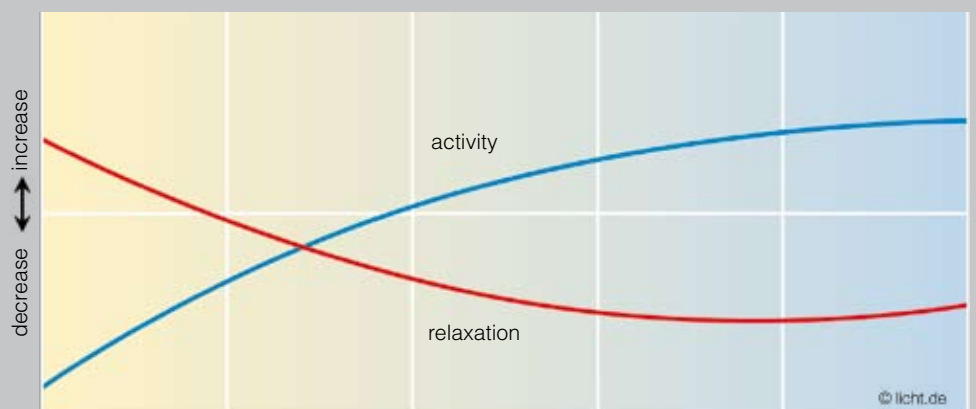

Source: Dr. Susanne Fleischer, Institute of Hygiene and Occupational Physiology, Swiss Federal Institute of Technology.

29

colour temperature (K) →  
warm white 3,000 K

daylight white 5,600 K



30

### Light as a therapeutic tool

Apart from the possibilities of supporting day/night rhythm, light – in the form of high illuminance in the field of vision - can also be used for therapy. A relatively new area of research is looking at its efficacy in treating seasonal affective depression (SAD) Also known as "winter depression", SAD affects 5 % to 20 % of the population and is characterised by lethargy, tiredness and even a craving for chocolate (in contrast to classical depression, which is characterised by loss of appetite). The milder form of SAD, known as "winter blues", is a growing phenomenon. Special high-illuminance luminaires with a colour temperature over 5,300 kelvin act as a natural antidepressant and can help ease the symptoms of SAD.

The operators of hospitals, care homes and other healthcare facilities are particularly advised to work with companies, architects and lighting designers that have already acquired ample experience in the area of biologically effective lighting and daylight utilisation. They can be involved in planning at an early stage, contribute extensive knowledge of luminaires, light sources, lighting control and daylight utilisation systems and guarantee a professional lighting solution that will last a long time and cater optimally for the needs of patients and residents.

 Further information on this subject can be found in the booklet licht.wissen 19 "Impact of Light on Human Beings".

[31] Cortisol and melatonin run in opposite cycles: cortisol is produced in the body in the morning, its concentration in the blood peaking at around 9 a.m. and then steadily declining during the day. Melatonin production starts at night and the level peaks at around 3 a.m.

[32] The angle of incidence from above and from the front is crucial for the biological impact of light. As shown in the illustration, the receptors in the lower part of the eye are particularly sensitive to the blue light that activates the body.

### Influence of daylight on the human body

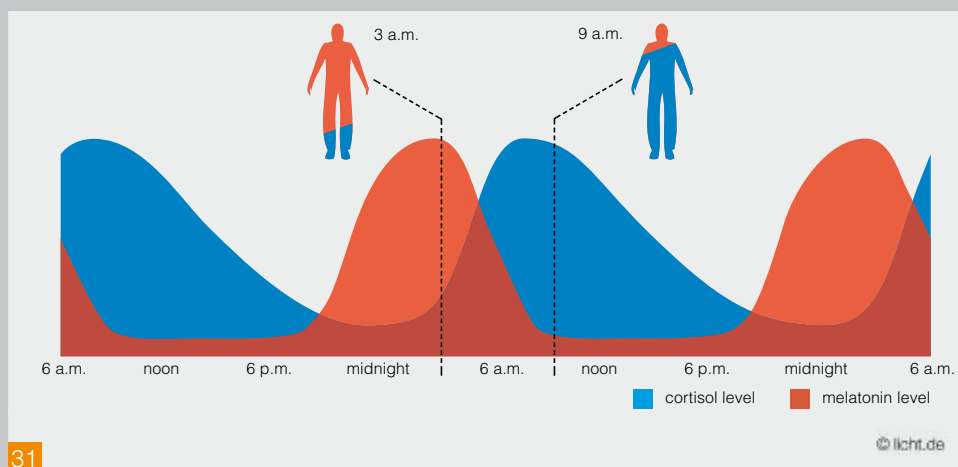

31

### Angles for effective blue light

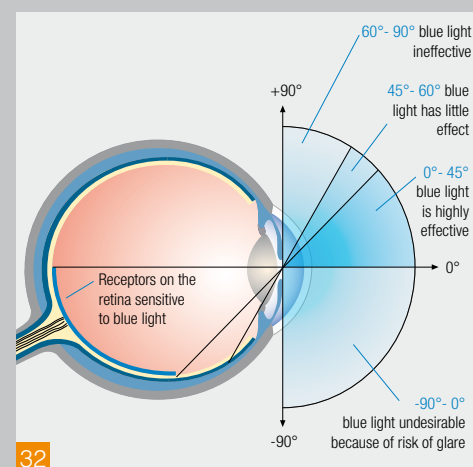

32

# Operating theatre and ancillary room lighting

During operations, surgical teams face very high mental and physical challenges. Reliability and functionality have top priority here. To permit reliable performance of the difficult visual tasks involved in what are often life and death procedures, optimal lighting is essential.

Performing surgery calls for total concentration, skill and absolute precision in every hand movement. To enable a surgical team to work properly, the lighting needs to meet the highest requirements.

Operating theatre lighting has to provide the right light for more than just the operating table. Lighting also needs to be furnished for the surrounding area. For an optimal lighting solution, the room is divided into three distinct zones. The brightest zone in the room is the operating field. 40,000 to 160,000 lux is required here for compliance with standards. But the rest of the room also needs to be very brightly illuminated in order to rule out the risk of adaptation problems for the eye and visual fatigue due to excessive differences in luminance. So, 2,000 lux should be the target illuminance for the immediate vicinity of the operating table; 1,000 lux is sufficient in the rest of the room (see also Fig. 35 on the right).

## Ultra-demanding visual tasks

For the supreme mental and physical performance required in the course of an operation, interference-free vision is a must. The general lighting in the operating area needs to supply particularly uniform light that avoids creating shadows and permits both virtual freedom from glare and fatigue-free work. Colour rendering is an extremely important factor throughout the room but especially in the operating field: a colour rendering index of  $R_a$  90 or higher is required here so that the surgeon can reliably distinguish between different types of tissue. To ensure good lighting quality across all zones, the light colour and colour rendering characteristics of the general lighting should be similar to those of the operating lights. It is imperative that glare, shadows and reflections should be avoided in the operating area itself and in the area around it. Articulated arms for flexible adjustment of the operating lights

and full gimbal mounting for the luminaire head enable light to be optimally directed onto the operating field.

## Agreeable atmosphere in waiting areas, pre-op and recovery rooms

To maximise support for patients in the difficult phases before and after surgery, a lighting installation that permits the colour of light to be flexibly adjusted or programmed is a very good idea. Dynamic changes in light colour and intensity create an atmosphere that has a soothing effect on patients.

Coloured light is even often used in operating theatres today – as a supplement to the functional lighting. It is activated, for example, to help relax and distract patients undergoing surgery under local or regional anaesthetic. Individual control of the different light colours enables an infinite number of lighting situations to be created. Excessively bold colours – also on walls, ceiling and room furnishings – should be avoided so as not to interfere with colour rendering in the operating area. In the recovery room, warm-white light is used immediately after the operation; once the patient is awake, biologically effective light can be used to help accelerate recovery.

Recovery room lighting is required to perform two tasks – to supply general lighting and to provide a much lower level of lighting in the recovery phase so that the patient is not dazzled. Indirect lighting is the best solution here. Supplementary lighting should be made available at the bed so that the illuminance can be raised if required.

[33] Modern operating theatres are subject to enhanced safety and hygiene standards, which also cover lighting. To facilitate hygiene and cleaning, it is recommended that luminaires should be protected to IP54 or IP65.



33



34

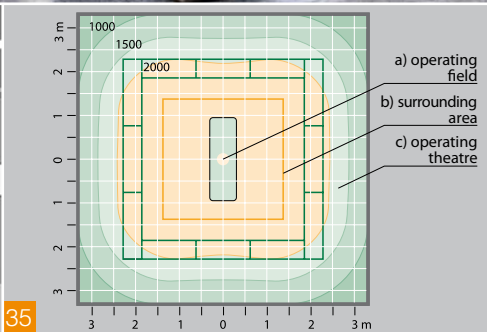

35

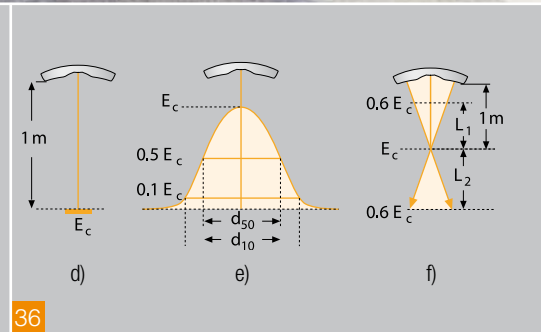

36

Task or activity area (values according to DIN EN 12464-1 and DIN 5035-3)

	$\bar{E}_{Lux}$	UGR <sub>L</sub>	U <sub>o</sub>	R <sub>a</sub>
Pre-op and recovery rooms	500	19	0.6	90
- Aufwachphase	100	-	-	-
- Zusatzbeleuchtung im Bedarfsfall	1,000	19	0.6	85
Operating theatres	1,000	19	0.6	90
Operating field, immediate surroundings	2,000	19	0.7	90
Operating field	40,000-160,000	19	0.7	90

$\bar{E}_{Lux}$ : illuminance, UGR<sub>L</sub>: glare, U<sub>o</sub>: uniformity, R<sub>a</sub>: colour rendering

## Operating theatre lighting zones and operating field lighting

The lighting designer needs to distinguish between three zones in an operating theatre [34, 35]: a) the operating field, where 40,000 to 160,000 lux central illuminance is the standard requirement to guarantee optimal conditions for surgery. b) the immediate surroundings of the operating table, where an average of 2,000 lux needs to be achieved. c) the operating theatre, where 1,000 lux background brightness is a minimum requirement on a plane 1 metre above floor level. This avoids adaptation problems for the eye as well as visual fatigue due to excessive differences in luminance.

Surgical luminaires [36] are covered by the standard DIN EN ISO 60601-2-41 "Medical electrical equipment, Part 2-41: Particular requirements for basic safety and essential performance of surgical luminaires and luminaires for diagnosis". Among other things, this standard contains stipulations for central illuminance  $E_c$  (up to 160,000 lux), luminance gradients in the operating field, light cone and beam path.

d) The central illuminance  $E_c$  at a distance of 1 metre from the luminaire should be between 40,000 lux and 160,000 lux.

e) The luminous field diameter  $d_{50}$  must be no less than 50% of the luminous field diameter  $d_{10}$ :  $d_{50} \geq 0.5 \cdot d_{10}$

f) The distance permitted between the luminaire and the working plane depends crucially on the illumination depth of the light. Illumination depth  $L_1 + L_2$  defines the area within the optical axis of the surgical luminaire in which 60% of central illuminance is still achieved.



37

General lighting, operating field lighting and, where appropriate, supplementary emotional lighting can be regulated by lighting control systems with an interactive display or telemedical touch panels.

#### Minimally invasive surgery

In minimally invasive surgery, surgical procedures are observed either indirectly via monitors or directly via an eyepiece and visual channel. Separately switched, dimmable room lighting delivering low-illuminance green light has become the solution of choice for this type of surgery.

Green light minimises interference caused by reflections on monitors. For the same reason, not just room lighting but also surgical lights come with a green-light endoscope mode. However, pre- and post-op procedures require the same standard of lighting as conventional surgery. So lighting for micro-invasive surgery always needs to be furnished as supplementary lighting.

#### Clean room lighting criteria

Nowhere in a hospital is protection from germs and contaminants as important as

in an operating theatre. Pathogen transfer is a constant risk for patients who are in a weakened state of health. Like all other fitments, luminaires must meet the higher safety and hygiene standards required. For simple hygienic cleaning, models protected to IP54 or IP65 are recommended. IP65 luminaires are not only dustproof but also practically bacteria-proof because only particles smaller than 1 µm can penetrate the housing. Higher degrees of protection are needed, in particular, where hygiene requires that walls and ceilings should be sprayed with cleaning agents and disinfectant.

A more difficult hygiene problem in operating theatres is sealing the room off from the ceiling void. For fitments installed in the ceiling, e.g. recessed luminaires, mounting frames are a proven solution. They guarantee both hygienic luminaire mounting and a clearly defined connection with the adjoining ceiling material. What is more, clean rooms in most hospitals operate at overpressure, so air can flow only from the clean room to adjacent rooms and the ceiling void, and not the other way around.

#### Efficient lighting installations offer high energy-saving potential

Modern LED and fluorescent lamps enable a great deal of energy to be saved, especially in the high illuminance environment of a surgical suite. The investment is recouped fairly quickly, not least because of low maintenance costs.

[37] Minimally invasive surgery is performed in low-illuminance green light to permit clear recognition of the three-dimensional images on computer monitors.

[38, 41] In operating theatres and surgical suite ancillary rooms, care needs to be taken to ensure that lamps generate neutral-white light of identical colour temperature. The minimum colour rendering index required is  $R_a 90$ .





38



41



39



40

## Safety lighting systems and emergency power

Safety lighting systems [39] in healthcare facility buildings are automatically activated in an emergency and make it possible for patients, staff and visitors to find their way around the building in the event of a mains power and general lighting failure and to exit the building quickly if they find themselves in danger. Safety and escape sign luminaires are a vital requirement for that. They point the way to escape routes and safety equipment and thus provide swift access to key items of equipment such as fire extinguishers. They thus help reduce risks and save lives in buildings. For compliance with DIN EN 1838, a minimum of 1 lux horizontal illuminance is required along the central axis of an escape route up to two metres wide.

In hospitals, emergency lighting is required to provide backup lighting [40] as well as safety lighting for escape routes. The mains-independent backup lighting needs to operate on a separate circuit to ensure that a surgical procedure can be completed as if no power failure had occurred. DIN VDE 0100-710 requires backup lighting for various zones in hospitals, surgeries and medical centres. It needs to be provided, for example, in Group 1 rooms (examination and treatment rooms) and Group 2 rooms (operating theatres and intensive care rooms), i.e. in rooms where vital services must not be interrupted.

## Medical supply units

Medical supply units bring high tech to the bedside or to where it is needed. Ready-for-connection modules help nurses, doctors and patients by providing direct access to important services – e.g. medical gases, electricity, telephone and Internet – as well as variable lighting.

Medical supply units – MSUs – perform a variety of important tasks in the day-to-day life of a hospital. Supplied ready for connection as individually tested modules, they incorporate all the connections, supply lines and controls needed to provide a patient with light, electricity, communications and medical gases. Integrated controls or a remote control device permit user-friendly management of features such as lighting.

**Lighting situations at the push of a button**  
Depending on the model, an MSU incorporates all the major lighting components. What is more, patient, doctor or

nurse has direct push-button access to the following:

- minimum of 100 lux indirect general lighting
- minimum of 300 lux reading light
- minimum of 300 lux examination light for nursing procedures and simple examinations (minimum of 1,000 lux for examinations and treatments)
- orientation light
- 5 lux night lighting for simple staff procedures

More information about patient bed lighting is found on page 13.



### Medical Devices Directive

The EU Medical Devices Directive is the regulatory instrument created to guarantee the safety and the medical and technological efficiency of medical products across the European Economic Area. These highly sensitive products need to meet very special requirements and may only be sold and operated if they conform to the Medical Devices Directive, which was incorporated into German law on 2 August 1994 in the form of the Medical Products Act (MPG). Apart from that, they must comply with a number of other medical product ordinances, such as the Medical Devices Operator Ordinance (MPBetreibV), which regulates the design as well as the operation and use of medical devices. Medical supply units (MSUs) are regarded as Class 11a medical devices if they are also designed to supply medical gases and/or vacuum. They need to be manufactured and individually tested in line with EU directive 93/42/EEC and standards EN 60601-1 ("Medical electrical equipment – Part 1) and EN ISO 11197 ("Medical supply units"). The CE mark – which needs to be displayed with the number of the Notified Body in the case of Class II and III products – certifies that the product was manufactured in conformity with statutory requirements and standards, but it is not a test mark. The quality management of medical supply unit manufacturers is certified by EN ISO 13485.

### Interior design possibilities

Medical supply units are available as horizontal or vertical models and can thus make very different interior design statements. They furnish designers with a functional, room-defining design tool that leaves the ceiling installation-free and makes the room feel more homely. Other options include full wall-lining panels – often with coloured or material mix highlights – or modules that are fully integrated in the wall for easy access to the featured components and connections.

### Economical, variable installation

MSUs are preassembled and tested by the supplier, which facilitates installation and operational cost planning. There is no need for expensive in-wall installation.

### Normative requirements

MSUs need to conform to the international standard DIN EN ISO 11197 "Medical supply units". They are products as

defined by the German Medical Products Act (MPG) and must also comply with the EU Directive 93/42/EEC (see also grey info box on page 26).

### Ready for the future

Medical supply units are intrinsically designed to permit modification and retrofitting. In contrast to in-wall installations, new modules can be quickly and easily upgraded or old and defective components replaced. MSUs can thus be updated with the latest technology, tailored to patients' requirements and equipped to meet new medical needs. The use of modern LED luminaires makes for lighting that is energy efficient and requires little maintenance.

MSUs are a sustainable investment. Flexible and economical installation, low maintenance and future-proofing for new technologies – both in medicine and in lighting – make them an indispensable tool in the healthcare sector.

[42] In-wall high tech makes the room look homelier.

[43] Vertical supply units integrate high tech and lighting – and ensure maximum comfort and convenience.

[44] MSUs meet vital medical needs in neonatal units.



# Examination and treatment room lighting

An examination room needs to fulfil a wide variety of functions and often doubles as an office, treatment room and patient interview room. To meet the relevant requirements, the lighting thus needs to be readily and flexibly adjustable.

In an examination and treatment room, a bright and cheerful atmosphere that radiates warmth inspires confidence, promotes a sense of security and has a calming effect on patients. The right lighting, in combination with homely, clearly arranged furnishings, forms a crucial basis for that. For the room and general lighting needed for examinations or treatment, direct and indirect ceiling luminaires with LEDs or with compact or linear fluorescent lamps are a suitable option. For compliance with DIN 5035-3, a minimum of 300 or 500 lux illuminance (depending on the particular field of medicine) needs to be provided throughout the room. As a general rule, patients find indirect lighting very agreeable and relaxing. It makes the room seem larger and less cramped. Where direct lighting is provided in the area of the examination couch, care must be taken to ensure that a patient facing the ceiling is not dazzled.

Static or mobile examination lights need to guarantee a minimum of 1,000 lux illuminance and at the same time ensure colour rendering of  $R_a$  90 or higher and a colour

temperature between 3,000 and 6,700 kelvin. LED luminaires are a good option here; they deliver energy-efficient light to the point of examination without generating significant heat.

## Multifunctional room use

For the doctor, the examination room is a multi-purpose facility. Apart from medical examinations, it is also used for patient interviews, VDU work and simple office activities. For tasks involving a monitor, the general lighting needs to be designed to avoid glare or reflections on the screen. If the room is also used for ultrasound or other scanning procedures, the lighting should be dimmable.

## Treatment rooms

Indirect dimmable general lighting is particularly recommended for treatment or therapy rooms. Depending on room use, it should be supplemented by high-intensity examination lighting. It may also be useful to create an agreeable and relaxing feel-good atmosphere through the use of coloured light. RGB colour

control enables any colour or dynamic sequence of colours to be projected onto walls or ceiling.

## Lighting management

Because examination and treatment rooms are used for variable purposes, lighting management systems are a particularly convenient option. They enable programmed lighting scenes for a wide variety of tasks to be activated at the push of a button from a display panel, computer or mobile phone.

[45] Indirect lighting, supplemented by a dedicated examination luminaire, provides both agreeable and functional light for the examination and treatment of patients.

[46] A pleasant lighting atmosphere produced by indirect lighting makes the room look larger and promotes a sense of wellbeing in patients.

[48] LED examination lights avoid significant heat gain in the area of the examination.





46



47



48

## Examination light

A good examination light [47, 48] is distinguished by bright light (1,000 lux), a very good colour rendering index of at least  $R_a$  90 and easy, functional operation. The possibility of varying light colour and intensity is also an advantage, e.g. for the diagnosis of skin disorders or for reducing reflections. LED luminaires are particularly suitable here because of their high light output, low heat generation in the treatment area and energy efficiency. They thus permit the problem-free completion of even time-consuming treatments.

Examination rooms:

Task or activity area (values according to DIN EN 12464-1 and DIN 5035-3)

	$\bar{E}_{\text{Lux}}$	UGR <sub>L</sub>	U <sub>o</sub>	R <sub>a</sub>
General lighting	500	19	0.4	90
Examination / treatment	1,000	19	0.4	90
Plaster rooms	500	19	0.4	80

$\bar{E}_{\text{Lux}}$ : illuminance, UGR<sub>L</sub>: glare, U<sub>o</sub>: uniformity, R<sub>a</sub>: colour rendering

# Energy efficiency and refurbishment

Hospitals work 24/7 – which means they are in operation for 8,760 hours a year. According to a Fraunhofer Institute study, a major German hospital with an average floor area of 16,400 square metres consumes around 1,800,000 kilowatts of electricity a year. That is as much as a small town. So a start needs to be made to conserve resources and cut costs.

High electricity consumption and the energy costs connected with it offer considerable savings potential for hospital operators. In March 2010, Germany's Federal Ministry of Economics and Technology launched a research project designed to identify that potential and lower consumption. Called "Krankenhaus plus", the project casts a scientific eye over hospitals' energy footprint with a view to achieving radical improvements in energy efficiency.

As far as lighting is concerned – which accounts for around 22% of the electricity consumed in a hospital – such improvements are already fairly easy to achieve. The first step, in most cases, is to switch to the latest high-efficiency light sources and luminaires with modern operating devices and reflectors. Opportunities for improvement can also be harnessed by making optimal use of daylight and integrating presence detectors and lighting management systems.

### Identifying savings potential

Identifying where savings can be made in lighting calls for systematic research. A map needs to be created and feasibility studies performed on the various lighting

installations. The longer the operating time in each case, the greater is the saving. An optimal refurbishment strategy can then be developed on the basis of the data collected and the calculations performed. It may be advisable, for example, to start with the rooms where the longest operating times are registered; alternatively, it could be best to start with the types of luminaire where the savings potential is greatest. The biggest savings are made where the two factors coincide. Refurbishment can then be performed in stages over a number of years.

### Energy Saving Ordinance (EnEV)

The German Energy Saving Ordinance (EnEV) transposes the EU Energy Performance of Building Directive (EPBD) into national law. It stipulates that when a building is planned or refurbished, the primary energy demand of the lighting needs to be calculated in accordance with pre-standard DIN V 18599, Part 4. Preliminary planning must comply with the guidelines of both the EnEV and the DIN standard cited in it. Types of luminaire used, hours of day/night-time use, size of windows, lighting management systems, surrounding buildings and other parameters are

[49] Savings possible in a general scenario when a building is refurbished with high efficiency luminaires and lighting management systems. In the case of a hospital, the anticipated savings potential is significantly higher – especially due to presence control, e.g. in corridors at night.

[50] A daylight-dependent lighting regulation system supplements incident daylight indoors with the required amount of artificial light.

[51, 52] Before and after a hospital corridor refurbishment: old fluorescent lamps with conventional ballasts are replaced by modern LED luminaires.

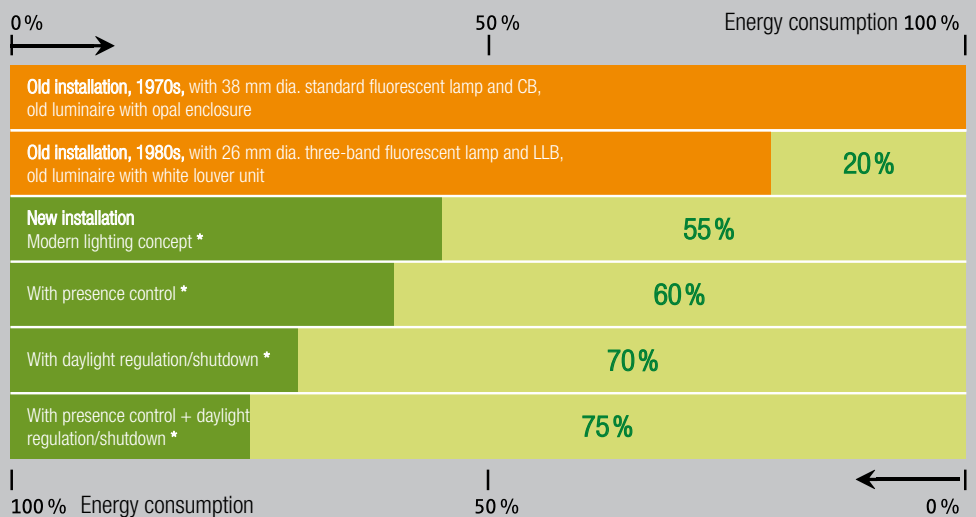

49 \* 16 mm diameter fluorescent lamp operated by EB with very low power loss, energy-efficient direct or direct/indirect luminaires with modern optical control technology.

factored into the energy requirement calculation. The primary energy demand needs to be below a defined benchmark. This requirement needs to be met before a building permit or energy certificate is issued. Energy efficiency requirements will become even tougher in future, with lower benchmarks raising the bar for acceptable efficiency standards. Operators are also under pressure to act because of rising energy prices.

#### Savings potential: lamp replacement

The fastest way to optimise energy consumption is by the one-to-one replacement of obsolete lamps in existing luminaires. There is a wide range of efficient retrofit light sources, energy-saving and LED lamps on the market. In the most favourable cases, the energy required can be reduced by as much as 80%. However, it is important to ensure that refurbishment does not result in poorer light distribution, illuminance or colour rendering. What is more, some retrofits are not designed for use with certain luminaires, so the luminaires may lose their certification.

Obsolete fluorescent lamps with conventional ballasts (CBs) are still a familiar sight in the health sector. Where they are present, the entire lighting system should be replaced because only luminaires with modern light sources, good reflectors and electronic ballasts (EBs) can offer an adequate quality of light and energy efficiency.

The once widely held view that LED lamps supply only cold, clinical light has long been disproved. LED lamps today are available in colour temperatures below 3,300 kelvin, comparable with conventional incandescent lamps.

#### Luminaire refurbishment makes for long-term savings

Lamp replacement works up to a point but greater savings can be achieved by modernising entire lighting installations. Obsolete luminaires offer poor quality of light and cause unnecessarily high power costs. The light output ratio of old lighting systems and components such as lamps, luminaires and operating devices can decrease by half over the years as a result of ageing and soiling of materials.

Modern light sources such as T5 fluorescent lamps and LEDs have a much higher luminous efficacy rating. What is more, modern electronic ballasts reduce power losses while making for a flicker-free start and better starting performance. The latest reflector materials and optics ensure high power efficiency and optimal luminaire shielding.

The annual operating costs of a hospital can be significantly lowered by an investment in efficient modern lighting. Because it is in operation 24/7, even higher acquisition costs are recouped in the space of a few years. Maintenance costs are also appreciably reduced.

#### Daylight utilisation and lighting management

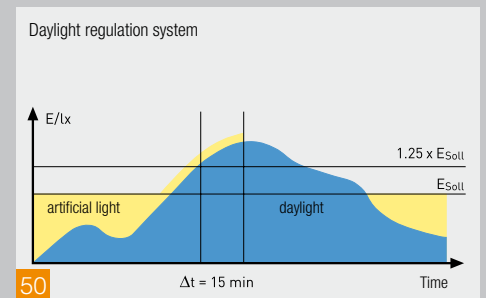

Daylight provides the high quality of light needed to cater optimally to human lighting requirements. Indoors, an intelligent daylight regulation system can ensure the right mix of artificial light and daylight for comfort and efficiency. A sensor registers the brightness in the room and activates the artificial lighting only in the parts of the room where it is needed. Bright walls, ceilings and floors also reduce lighting requirements. Modern lighting management systems and dimmable luminaires with EBs compatible with digital interfaces such as DALI or KNX are a prerequisite. Significant savings potential is also offered by presence detectors integrated into the system in corridors or ancillary rooms to activate lighting only when the room is in use.

Further information on lighting management is found in the Lighting Special "LED, lighting management and daylight utilisation" on page 57.



51



52



53

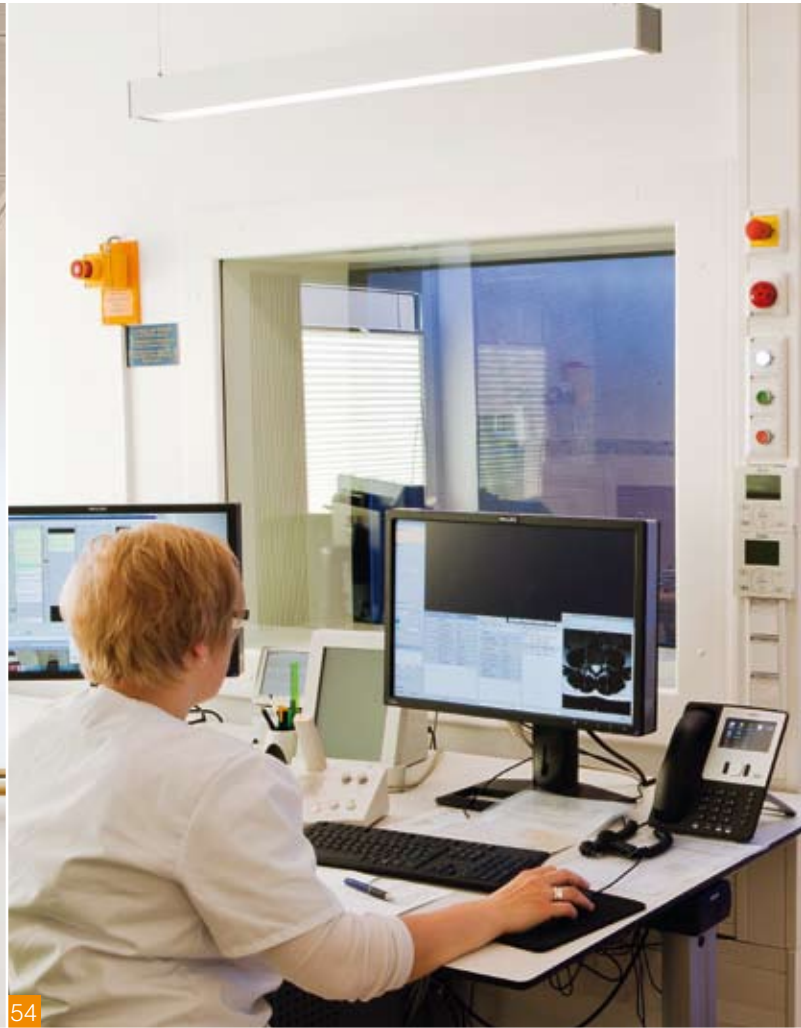

54



55



56



# Ancillary room and outdoor area lighting

The ancillary rooms and outdoor facilities of a hospital require special lighting solutions. From the facade that makes the first impression to the room where nurses take a break - everything needs to be effectively and functionally illuminated as well as energy efficient and low-maintenance.

Hallways and corridors are the main traffic arteries of a hospital, so bright, professionally designed lighting is important here for patients, visitors and staff. DIN 5035-3 stipulates that 200 lux illuminance needs to be provided during the day – even more than that, 300 lux, in the corridors of a surgical wing. At night, 50 lux is sufficient for orientation. Because these areas are used 24/7, the issue of energy efficiency is central to design considerations, along with functionality and safety. LED luminaires are a particularly attractive option in this regard because of their high energy efficiency and low maintenance requirements. To ensure that lighting couples economy with comfort, ceiling lights should be designed to avoid glare for patients on trolleys. The best solution here is vertical wall-washing light. Functionality is thus combined with attractive interior design.

maceuticals and managing their dispensation; they are also used as staff rest rooms and offices. Where office duties are performed, lighting requirements are the same as for any other office. Freedom from glare and reflections is particularly important for VDU work. For nurses' rooms or rooms used for rest breaks, which are available day and night, individually controlled and dimmed lighting is also recommended. At night, bright lighting can help prevent the onset of early fatigue among nursing staff. For procedures and operations that require higher illuminance, installations delivering directional, neutral-white light are recommended.

Different lux levels and lighting atmospheres can be realised most conveniently by simple lighting control systems primed to activate individually definable, pre-programmed lighting scenes.



## VDU work

Good lighting [54, 56, 57] should be tuned to the visual task performed and tailored to the visual capacity of the user. It must also create a balanced contrast between VDU screen and workplace surroundings to avoid early visual fatigue due to constant adaptation. VDU workplace design and lighting need to ensure that no interference is caused by glare or reflected light or images on screens and work materials.

Task or activity area (values according to DIN EN 12464-1 and DIN 5035-3)

	$\bar{E}_{Lux}$	UGR <sub>L</sub>	U <sub>o</sub>	R <sub>s</sub>
Workplace	500	19	0.6	80
Surrounding area	300	19	0.4	80

$\bar{E}_{Lux}$ : illuminance, UGR<sub>L</sub>: glare, U<sub>o</sub>: uniformity, R<sub>s</sub>: colour rendering

### Adaptation

Corridors should give hospital staff's eyes time to adapt. Differences between bright and dark rooms and any glare effects that may result from them can be significantly reduced by pitching illuminance in corridors at a moderate level.

### Waiting rooms: instilling confidence

Nervousness and uncertainty can make a spell in a waiting room a stressful experience. Warm light (approx. 3,000 kelvin) cast by wall, ceiling or free standing luminaires can be usefully deployed here to create a reassuring, homely atmosphere. RGB light control can also be integrated to permit variable, programmed coloured lighting, e.g. yellow light for a soothing effect or slowly changing colour sequences for visual interest.

### Doctors' and nurses' rooms: workplace and rest room in one

Rooms in which no actual medical services are performed often serve a wide variety of purposes. They are used for storing phar-

[53, 55] Coloured highlights on walls set design accents and make corridors look attractive and interesting.

[54, 56] VDU workplace lighting needs to be carefully planned. Screens should be illuminated to ensure freedom from both glare and reflections.

#### Parking facility lighting

The outdoor areas of a hospital should be attractively designed to encourage patients and visitors to linger or take a stroll. This can have a lasting positive impact on the patient recovery process. Column and bollard luminaires are a good choice for night-time lighting; so are recessed ground spots. At hazards such as stairs or steps, DIN EN 13201-2 "Road lighting- Part 2: Performance requirements" requires 2 to 10 lux illuminance, depending on lighting class.

#### Car-park safety

Column luminaires with high-precision light-controlling optics for tailored dark zone free lighting are the solution of choice to ensure that car-parks are safe for pedestrians, cyclists and motorists. The illuminance required - preferably delivered by LED luminaires or metal halide lamps – depends on the average volume of traffic: 20 lux is needed for high, 10 lux for moderate and 5 lux for low traffic vol-

umes. The relevant requirements are set out in DIN EN 12464-2 "Light and lighting – Part 2: Outdoor work places".

#### Good lighting for a healthy appetite

Canteens and cafeterias are not just catering facilities; they are places where people go to unwind, meet others and chat. The surroundings need to be such that people feel good, relax and can swiftly recharge their batteries. Rooms that are flooded with light and have a cheerful communicative atmosphere promote rapid regeneration. Where artificial lighting is required to supplement daylight, energy-optimised lighting technology needs to be coupled with modern lighting management to ensure standard-compliant, efficient, flexible lighting.

Surface-mounted or recessed luminaires as well as spots and luminaires on power track are recommended for cafeteria background lighting. A combination of pendant

luminaires assigned to seating groups and wall lights for brightening ceilings and walls is an effective alternative. The standard DIN 5035-3 recommends 200 lux background lighting for dining areas.

Food presented under lights with a high colour rendering index looks natural and appetising. At serving counters and pay points, care should also be taken to avoid glare.

Designing canteen and cafeteria lighting calls for very special technical and design concepts. A good lighting solution here makes for restful breaks and constructive communication.



[58] Coloured light turns waiting areas into feel-good zones. Dynamic colour sequencing helps patients relax and prepare for an anticipated examination or treatment.

[59] Efficient downlights with a good colour rendering index facilitate flexible room use and make for an attractive lighting atmosphere.

[61] well-lit facade makes a positive impression on patients and visitors from the outset.

Task or activity area (values according to DIN EN 12464-1 and DIN 5035-3)

	$\dot{E}_m$ Lux	UGR <sub>L</sub>	U <sub>o</sub>	R <sub>a</sub>
Waiting rooms	200	22	0.40	80
Corridors: during the day	200	22	0.40	80
Corridors: during the night	50	22	0.40	80
Multiple use corridors	200	22	0.60	80
Corridors in surgical suites	300	19	0.60	80
Day rooms	200	22	0.60	80
Passenger and visitor lifts	100	22	0.60	80
Service lifts	200	22	0.60	80
Staff office	500	19	0.60	80
Staff rooms	300	19	0.60	80

$\dot{E}_m$ : Lux; illuminance, UGR<sub>L</sub>: glare, U<sub>o</sub>: uniformity, R<sub>a</sub>: colour rendering



59

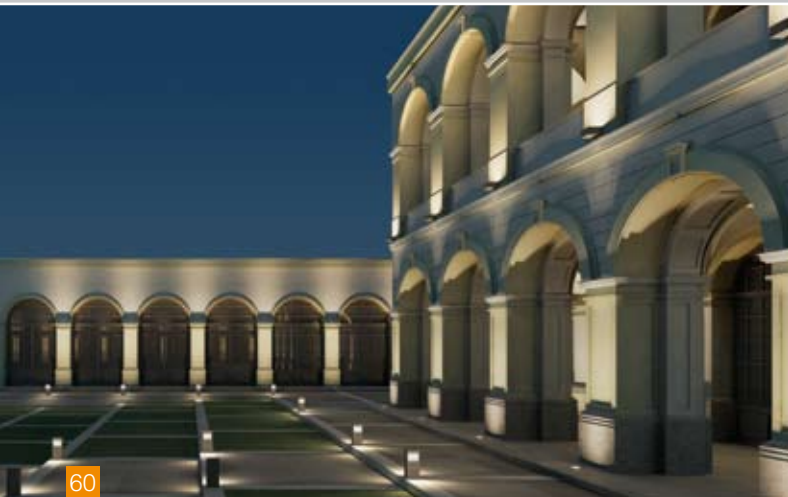

60

## Facade lighting

Facade lighting [60, 61] highlights a building at night and gives it a totally different appearance from during the day. However, an interesting and attractive design of light and shadow can only be produced by a combination of lights positioned close to and at a distance from the building. Special architectural features can be emphasised by glancing light from asymmetrical recessed ground lights set close to the building. The emission characteristics and thus illuminating effect of the luminaires can be adjusted by the use of reflectors and lenses. But glancing light does more than just brighten walls; it also underlines their materiality and surface structure. Details such as window reveals, cornices and plasterwork can additionally be highlighted by energy efficient LED wall luminaires without causing light pollution.



61

# Rehabilitation lighting

The primary aim of rehabilitation is to support patients in the process of convalescence and offer them the help they need to regain their physical and mental health.

Patients in rehabilitation have often gone through a protracted period of illness. Special therapies are provided to help further stabilise their condition and prepare them for a return to working life or a maximum of independence at home. Relaxation and a sense of wellbeing are particularly important during this phase. Harmonious surroundings and the right light make a crucial contribution to a swift recovery.

## Room and accent lighting

A balanced mix of room and accent lighting in a therapy room can help create a pleasant general atmosphere in which patients feel safe, secure and at the same time emotionally supported. The underlying brightness required for the room can be provided by indirect lighting – bounced off illuminated walls or ceilings – or by direct lighting with planar LED luminaires or luminaires with linear fluorescent lamps. Lighting accents are set by downlights or spots casting focused light onto walls, pictures or plants in the room. It is important here to ensure that glare due to high luminance in the direct field of vision is avoided for both patients and staff.

In treatment and therapy rooms used for physical, radiological and electromedical procedures, DIN standard 5035-3 generally requires a minimum of 300 lux illuminance and a colour rendering index of  $R_a$  80. More intricate treatments and therapies require higher illuminance levels. A warm white colour tone below 3,300 kelvin is the light colour of choice.

## Coloured light

In rooms that are equipped, for example, with sterile-looking training equipment or treatment apparatus, functional room lighting can be very effectively overlaid with coloured lighting accents – either in the form of a slowly changing sequence of soothing colours or as a single static mood colour.

## Swimming and exercise pool lighting

In aqua therapy rooms, special attention needs to be paid to bright, glare-free lighting. Hazard areas such as steps or the pool edge are thus reliably recognised. Where direct light falls onto the water surface, reflected glare needs to be avoided for anyone at the edge of the pool. Swimming pools and exercise baths are particularly well served by underwater lighting (preferably with LEDs because of their long 50,000 hour lifespan). Underwater lights require a higher degree of protection; IP68 is a minimum. The IP code (Ingress Protection) defines a luminaire's resistance to penetration by dust and moisture. All luminaires used in damp interiors need to be splashproof and protected to at least IP34.

## The therapeutic effect of light

Light therapy has long been in use as a medical tool. Short-wave infrared radiation, for example, activates circulation, alleviates pain and promotes healing. Focused light with a near-solar spectrum helps in cases of skin complaints, while blue light is used to treat metabolic disorders in newborn babies. And everyone knows the salutary effect of red light on anyone with a cold. Light's healing impact can also be seen in special biologically effective luminaires that use high illuminance and short-wave blue light to treat SAD (seasonal affective disorders).

[62] Lots of daylight and supplementary artificial lighting are a good basis for successful therapy.

[63] Good light activates and motivates patients to keep on track to recovery.

[65] and foremost, light for exercise and swimming pools needs to ensure safety and good orientation.

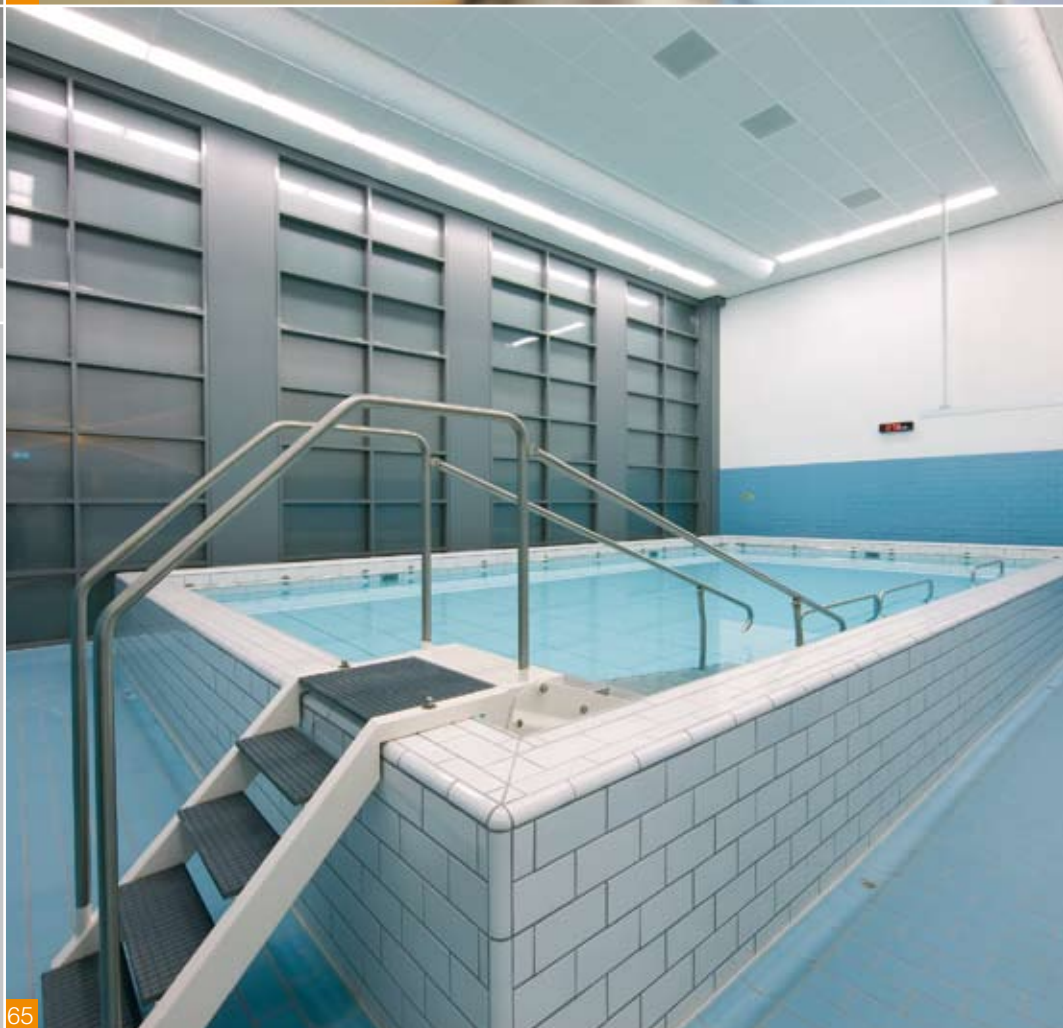

62

63

64

65

## Light for physiotherapy

In physiotherapy rooms, [64] bright light with a good colour rendering index – comparable to that required for doctors in examination rooms - is needed for diagnosis. For manual therapy and for physical exercises, the light can be an activating daylight white. For relaxation exercises and massage, on the other hand, the light should be warm and, above all, dimmable. An installation delivering partially coloured light can also make for a feel-good atmosphere.

Task or activity area (values according to DIN EN 12464-1 and DIN 5035-3)

	$\dot{E}_m$ Lux	UGR <sub>L</sub>	U <sub>o</sub>	R <sub>a</sub>
Waiting rooms	200	22	0.6	80
Plaster rooms	500	19	0.6	80
Medical baths	300	19	0.6	80
Massage and radiotherapy	300	19	0.6	80

$\dot{E}_m$ : Lux: illuminance, UGR<sub>L</sub>: glare, U<sub>o</sub>: uniformity, R<sub>a</sub>: colour rendering

# Standards and quality criteria for lighting

The requirements that need to be met by artificial lighting in healthcare facilities are particularly high. Standards and quality criteria define the quality of light required and take equal account of the needs of patients, doctors and nursing staff.

The normative requirements that need to be met by lighting in the health sector in Europe are set out in various rules and regulations. In 2011, an updated version of the standard DIN EN 12464-1 came into effect. It defines the most important requirements that need to be met by lighting in terms of parameters such as maintained illuminance ( $\bar{E}_m$ ), minimum uniformity ( $U_0$ ), glare ( $UGR_L$ ) and colour rendering ( $R_a$ ). In Germany, the standard DIN 5035-3:2006 "Artificial lighting – Part 3: Lighting of health care premises" also needs to be observed. It supplements DIN EN 12464-1 by setting out requirements for further types of interior, task and activity. The ordinances and technical workplace regulation ASR A3.4 adopted in April 2011 need to be observed as a matter of principle.

## Normative requirements at the patient bed

A reading light needs to be provided for every patient bed in a hospital. For reading, DIN EN 12464-1 requires a minimum of 300 lux at the patient bed. Furthermore, DIN 5035 3 defines the reading plane as a plane 300mm high and 900mm wide inclined

at 75° to the horizontal (see also Fig. 67). Where variably adjustable reading lights are used, it is enough if 300 lux is achieved over any 300 x 300mm reading area within the reading plane.

The risk of direct glare for the patient in bed must be ruled out. The luminance of all light sources and luminous surfaces within the patient's direct field of vision must be limited to 1,000 candela per square metre. Direct field of vision is defined as all points that can be perceived by a person reclining in a horizontal position with head turned at any angle. This applies particularly to the reading lights for beds on the opposite side of a shared room. The maximum permissible brightness of the ceiling in the patient's field of vision is 500 candela per square metre. For simple examinations or treatments performed at a patient's bed, DIN 5035-3 requires an average of 300 lux illuminance along the longitudinal axis of an examination plane 0.85m above floor level. The illuminance can be the cumulative result of all lighting components in the room.

[66, 67] Correct patient bed lighting is defined in DIN 5035-3. The standard stipulates how much lux is needed for the patient at different points around the bed. It also contains a precise definition of the treatment plane.



### Horizontal and vertical illuminance

Higher illuminance promotes concentration and facilitates work for nursing staff. What is more, higher illuminance indoors, in conjunction with dynamically changing light colours, has a biologically and emotionally positive effect on the patient. Bright walls and ceilings give rooms a cheerful atmosphere and are explicitly required by DIN EN 12464-1 and DIN 5035-3. Accordingly, walls (main surfaces) need to be illuminated to a minimum of 75 lux and ceilings to a minimum of 50 lux, with uniformity at least 0.10. The values stated here are always minimum values. Higher values are recommended for good visual comfort. In the individual chapters of this booklet, all the illuminance values required by DIN 5035-3 are listed in tables by type of interior, visual task or activity. The values stated are for normal visual conditions. Higher illuminance levels are required for more demanding visual tasks or for users with reduced visual acuity. In an infants' ward, for example, the 100 lux that is normally required for general lighting needs to be doubled because of the intensive care and monitoring tasks that are performed.

### Direct glare

Dazzling light interferes with perception and significantly impairs visual performance. As a result, mistakes are made due

to fatigue and poor concentration. Direct glare caused by direct eye contact with a light source or by marked contrast due to very bright and very dark surfaces is particularly problematical. It can be prevented by shielding, e.g. by louvers or special reflectors. Windows that are a potential source of glare should be fitted with a screening device.

### UGR<sub>L</sub>

The UGR (unified glare rating) method is applied on the basis of DIN 5035-3 to determine discomfort glare in terms of a UGR<sub>L</sub> limit. This defines the upper limit for the limitation of direct glare. It takes account of every luminaire in a lighting installation as well as the brightness of walls and ceilings. The applicable UGR<sub>L</sub> limits are shown in tables in the individual chapters of this booklet. The basic rule is: the lower the UGR<sub>L</sub>, the less glare caused.

### Reflected glare

Where work is performed at screens, e.g. for monitoring vital signs (ECG, blood pressure, blood oxygen level, etc.) or for verifying progress during endoscopic procedures, poorly shielded or incorrectly positioned luminaires can cause glare and reflections that interfere with concentration and prolong the examination.

Reflected glare is reduced by the following:

- dimmable lighting
- correct arrangement of monitors in relation to luminaires and windows
- shading for windows and skylights
- use of shielded luminaires
- low-luminance luminaires with a large luminous surface
- materials, surgical instruments, etc. with appropriate finishes (matt surfaces).

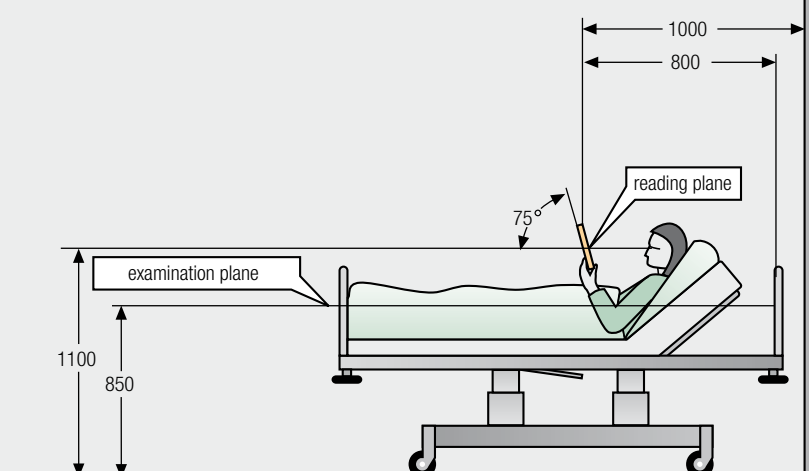
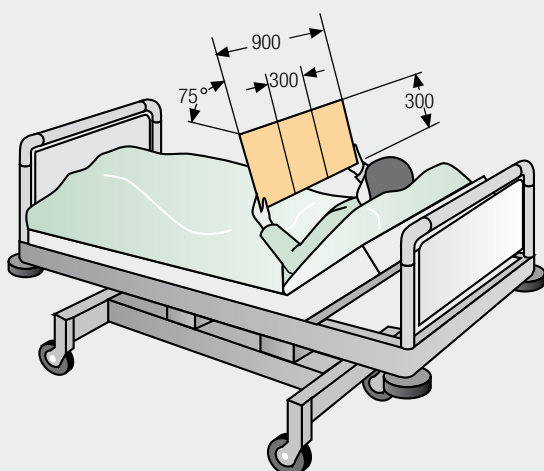

Example of lighting installation maintenance

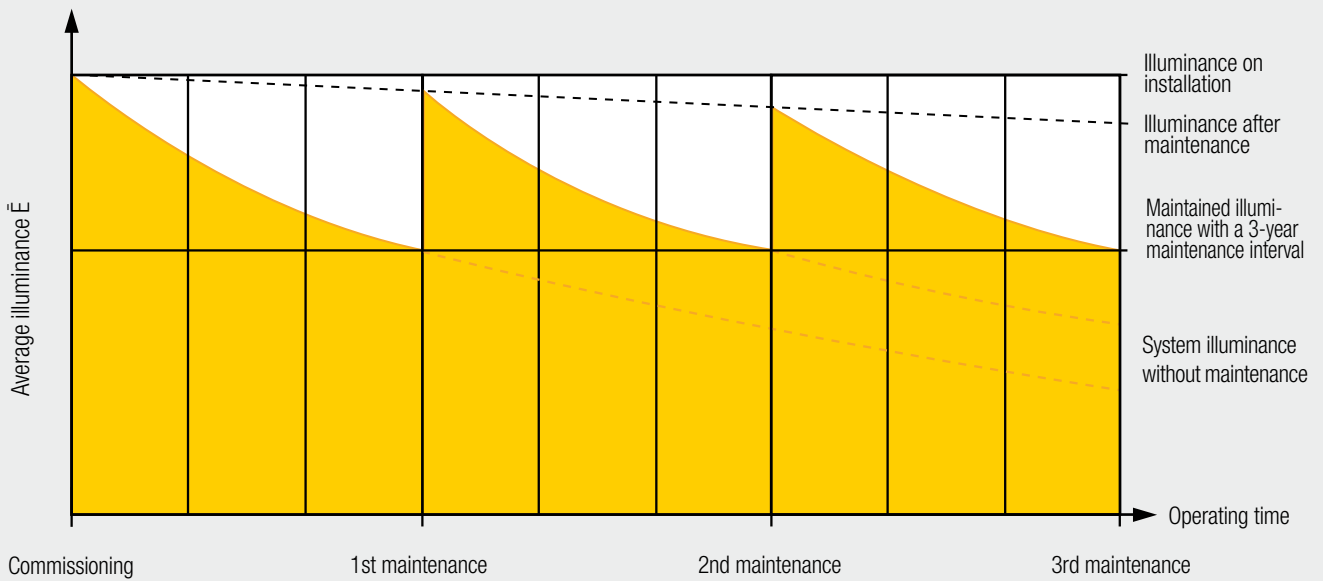

© licht.de

68

**Maintained illuminance**

Maintained illuminance is the value below which the average illuminance  $\bar{E}_m$  is not allowed to fall, regardless of the age or condition of the lighting installation. Illuminance gradually diminishes over the years as a result of ageing (luminaire components, ballasts and light sources) and soiling (luminaire housings and surrounding room). To allow for this, new installations are designed for a higher illuminance (value on installation), which takes account of the decline in illuminance over time.

DIN EN 12464-1 stipulates that the maintenance factor should be agreed between the designer and operator of the lighting installation. To meet hygiene requirements, the following benchmark factors need to be applied for rooms in healthcare premises:

- 0.8 maintenance factor where duration of occupancy is brief or soiling light
- 0.67 maintenance factor where duration of occupancy is normal or soiling heavy

These values take account of the need for a higher degree of cleanliness in healthcare premises. Ancillary and supply rooms are subject to a higher degree of soiling.

**Uniformity, surrounding area, background**

Where there are very marked differences in brightness in a room, the eyes of staff and patients have to adapt constantly to

changing conditions. This quickly results in fatigue and impairs both visual performance and sense of wellbeing.

Uniformity ( $U_o$ ) is the ratio of minimum illuminance to average illuminance ( $U_o = E_{min} / \bar{E}$ ). DIN EN 12464-1 requires a uniformity ratio of at least 0.1 on walls and ceilings. Example: 50 lux minimum illuminance divided by 500 lux average illuminance produces a uniformity ratio of  $U_o = 0.1$ .

The illuminance of the immediate surrounding area – the area forming a band at least 0.5 m wide around the task area – can be lower than in the task area. However, it must not be allowed to fall below the following values:

Task illuminance $\bar{E}_{task}$ in lux	Illuminance of immediate surrounding areas in lux
≥ 750	500
500	300
300	200
200	150
150	$\bar{E}_{task}$
100	$\bar{E}_{task}$
< 50	$\bar{E}_{task}$

Uniformity  $U_o$  in the immediate surrounding area needs to be  $\geq 0.40$ . In rooms that are not well served by daylight, adequate illumination is also required for surfaces farther away – i.e. beyond the immediate surrounding area. This background is

defined as an area extending at least three metres out from the immediate surrounding area. Illuminance here should be no less than a third of that in the immediate surrounding area.

Wall or ceiling luminaires designed for indirect light distribution are particularly useful for illuminating a room uniformly. Accents can be set and an agreeable atmosphere created by supplementary direct beam luminaires.

**Shadows and modelling**

Objects can only be seen as three-dimensional figures if they cast a shadow. Light and shade also enable us to gauge distances better. The crucial requirement for 3D perception is the right mix of directional and diffuse light for "modelling". Modelling is the ratio of cylindrical to horizontal illuminance at a given point. For optimal results, it should be within a range of 0.30 to 0.60.

Deep shadows can present problems, especially for older people. Their eyes no longer adapt as swiftly to brightness and darkness. Care should also be taken to avoid multiple shadows, which can cause visual confusion. They occur where directional light falls on an object from more than one angle. Where light is directed onto persons from above, deep shadows can be cast over faces. This is particularly





69



70



71



72



73



74



75



76

undesirable in communication zones and can be avoided by installing lighting with a high indirect component.

#### Colour rendering and light colours

The standard of colour rendering achieved with artificial lighting is defined by the colour rendering index  $R_a$ . An  $R_a$  value of 100 means that colours are perceived exactly as they would be in natural light. Colour rendering values depend crucially on the spectral composition of the artificial light, i.e. on the type and quality of the light source. The minimum colour rendering index values required as standard for different applications are shown on the pages devoted to those applications in this booklet. The impression a room makes and our response to the colour tones in it depend crucially on the light colour of the lamps used. Lamp manufacturers offer light sources in a range of light colours.

In communication zones and rooms where a sense of personal wellbeing is desired, a warm white light colour with a colour temperature lower than 3,300 kelvin should be used. This creates a comfortable, homely atmosphere. In rooms that are used as work interiors, neutral white light colours with a colour temperature between 3,300 and 5,300 kelvin are recommended. And in rooms where precise identification of colours is imperative, e.g.

where dermatological examinations or surgical procedures are carried out, daylight white light with a colour temperature over 5,300 kelvin may be required, along with a particularly high colour rendering index of at least  $R_a$  90.

Light colour also impacts on human circadian rhythms. Light with a high blue content and a colour temperature over 5,300 kelvin has an activating effect while light colours below 3,300 kelvin act as calmatives. More information on this subject is found in the chapter "Biological impact of light on human beings" on pages 18-21.

[68] Illuminance gradually diminishes as a result of ageing and soiling. The table shows maintained illuminance over a 3-year maintenance cycle.

[69, 70] VDU work can be significantly disturbed by veiling reflections and reflected glare. Well shielded luminaires and daylight management can help counteract them.

[71, 72] To allow colour tones to be perceived as in natural light, artificial lighting needs a high colour rendering index.

[73, 74] Where desk lighting is required, the work surface should be illuminated from the left for right-handers and from the right for left-handers.

[75, 76] Where high-gloss surfaces are present, reflected glare needs to be avoided to enable work and reading tasks to be performed in comfort. Discomforting reflected glare can be prevented by indirect lighting.

# Doctor's surgery lighting

Light is needed for a wide range of activities in a doctor's surgery. From patient interviews in the consulting room to examinations in the examination room, to computer work at the reception desk – each activity requires its own specific lighting solution.

The reception is the calling card of a doctor's surgery. It is also the area where all information comes together. Reception lighting should therefore be bright and cheerful and at the same time help create an ergonomically correct VDU workplace for surgery staff. With vertical lighting – bounced off illuminated walls – the field of vision of patients and staff is well illuminated and the room seems generally larger.

To create the most positive reception possible and provide an orientation aid for visitors, the lighting designer should work with higher illuminance values over the counter to draw a dividing line between the reception and the waiting area.

Pendant luminaires or planar light are the recommended options for illuminating this brighter zone. Another elegant way to draw attention to the reception is to use light to accentuate the counter itself. (see Fig. 77).

### Reassuring light for the waiting room

A warm lighting atmosphere has a relaxing and reassuring effect in the waiting room. The general lighting here can also be very usefully supplemented by static or changing coloured light. DIN 5035-3 requires a background brightness of 200 lux for waiting rooms. To ensure sufficient light for patients, however, a higher level of illuminance is recommended.

### Consulting room, examinations and treatment

As a general rule, the illuminance required for a doctor's consulting room is 500 lux. On examination planes in examination and treatment rooms, it needs to be higher still: 1,000 lux. Moreover, certain medical specialisations call for even higher lighting levels or for lighting catering to very special requirements.

### Ophthalmology

Ophthalmic medicine is concerned with the diagnosis and treatment of eye and sight disorders. The surgeries where it is practised have very special lighting requirements: many eye examinations can



## Minimum lighting requirements for compliance with DIN EN 12464-1 and DIN 5035-3

Task or activity area	$\bar{E}_{\text{min}}$ LUX	UGR <sub>L</sub>	U <sub>0</sub>	R <sub>a</sub>
Examination rooms (general)				
General lighting	500	19	0.6	80
Examination and treatment	1,000	19	0.7	80
Plaster rooms	500	19	0.6	80
Dental treatment rooms				
General lighting	500	19	0.6	90
At the patient	1,000	-	0.7	90
Operating cavity	5,000	-	-	85
Colour matching teeth	1,000	-	0.7	90
Eye examination rooms				
General lighting	300	19	0.6	80
Examination of the outer eye	1,000	-	-	90
Reading and colour vision tests with vision charts	500	16	0.7	90
Scanner rooms				
General lighting	300	19	0.6	80
Scanners with image enhancers and television systems	50	19	-	80
Direct viewing on visual display units	30	-	-	80

$\bar{E}_{\text{Lux}}$ : illuminance, UGR<sub>L</sub>: glare, U<sub>0</sub>: uniformity, R<sub>a</sub>: colour rendering

only be conducted using a slit lamp. Outer eye treatments require a minimum of 1,000 lux illuminance. For certain examinations, however, only very low illuminance levels are permissible. General lighting thus needs to be dimmable, with a brightness control range from 10 to 300 lux. For reading tests, 500 lux vertical illuminance is a minimum requirement.

[77] The reception should be both cheerful and inviting but it also needs to permit glare free work at a computer screen.

[78] The examination and consulting room needs good lighting for examinations, consultations and VDU work.

[80] A dental treatment room needs well-coordinated general and examination lighting to ensure optimal visual conditions for the dentist.

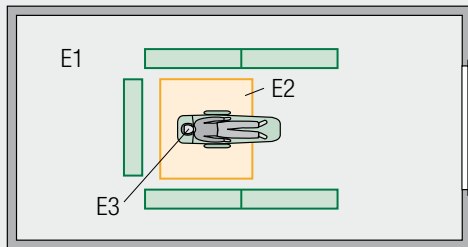

79

## Lighting zones in a dental treatment room

The dental treatment room [79, 80] is divided into three lighting zones. A minimum of 500 lux needs to be guaranteed around the examination chair (E1), 1,000 lux at the patient (E2) and at least 5,000 lux at the point of treatment. Throughout the room, the light colour should be neutral white or daylight white. To avoid glare, ceiling luminaires should generally be asymmetrical and should not be positioned within a 2.5 x 2.5m square in the patient's field of vision. The work of colour matching teeth in a dental laboratory calls for daylight white light with a colour temperature of 6,000 kelvin and a minimum illuminance of 1,000 lux as well as a very good colour rendering index of at least  $R_a 90$ .



### Radiology

Radiologists often require a darkened room to analyse the results of their work on the monitor. Dimmable and, above all, glare-free general lighting is particularly important here. However, the emotional state of patients – and thus their sense of wellbeing and confidence – can also be positively influenced by the right lighting concept. The use of dynamically changing light colours and illuminance levels – as well as coloured light – has a calming effect.

### Dermatology

Dermatologists diagnose and treat a wide variety of disorders of the skin. In order to do so, they need excellent lighting to permit accurate identification of minute changes in tissue colour. Neutral white or daylight white light is a must here and the colour rendering index needs to be  $R_a$  90 or higher. For compliance with DIN 5035-3, the 500 lux general lighting is supplemented by an examination light delivering at least 1,000 lux. Apart from that, special LED examination lights permit tailored adjustment of light colour and intensity so that the visual task is optimally supported, e.g. to prevent reflections on wet skin.

### Gynaecology and obstetrics

For gynaecological examinations, DIN 5035-3 requires 500 lux general lighting and at least 1,000 lux for examinations. To ensure that colours are rendered naturally, the examination light should have a very good colour rendering index of  $R_a$  90 or higher. LED examination lights offer major advantages because they cause minimal heat gain. The absence of disturbing heat sources at the point of treatment or diagnosis, especially during lengthy examinations, raises the comfort level for both patient and physician. The lighting also needs to be easy and intuitive to operate so that the medical team can concentrate on the task in hand without unnecessary distractions.

For deliveries in gynaecological surgeries or hospitals, dimmable indirect lighting is the solution of choice. 300 lux general lighting is required and supplementary coloured or colour change lighting can be provided for reassurance and relaxation. The lighting control unit can be conveniently operated via touch panel or PC. Any lighting atmosphere can thus be activated at the push of a button.

[81] Medical equipment often seems cold, technical and intimidating. Lighting can help overcome that impression by creating an atmosphere that produces a positive emotional response.

[82] A waiting area bathed in warm balanced light boosts confidence and has a reassuring effect on patients.

[83] Indirect lighting in combination with controlled coloured light makes for an agreeable lighting atmosphere and can be regulated to have an activating or calming effect on persons in the room.

[84] LED examination lights have the compelling advantage of generating little heat and allowing light colour and brightness to be adjusted.

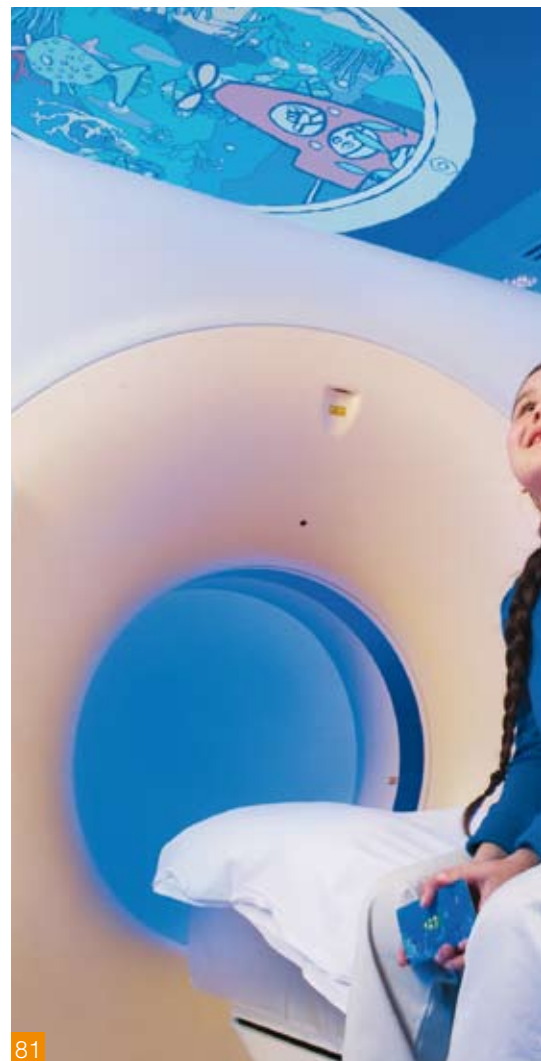

81

### Minimum lighting requirements for compliance with DIN EN 12464-1 and DIN 5035-3

Task or activity area	$\bar{E}_m$ Lux	UGR <sub>L</sub>	U <sub>o</sub>	$R_a$
<b>Delivery rooms</b>				
General lighting	300	19	0.6	
Examination and treatment	1,000	19	0.7	80
<b>Dialysis</b>				
Pre-op and recovery rooms	500	19	0.6	80
General lighting for comfort	100	19	0.4	80
Reading light	300	19	0.7	80
<b>Dermatology</b>				
General lighting	500	19	0.6	90
<b>Endoscopy rooms</b>				
General lighting	300	19	0.6	80
Endoscopic examinations	50	-	-	80
<b>Ear examination rooms</b>				
General lighting	300	19	0.6	80
Ear examination	1,000	-	-	90

$\bar{E}_m$ : Lux: illuminance, UGR<sub>L</sub>: glare, U<sub>o</sub>: uniformity,  $R_a$ : colour rendering



82



84

83

# Age and vision

With the right lighting, the poorer visual acuity experienced in old age – accompanied by sharply reduced colour and depth perception and slower adaptation - can be significantly improved.

The eye is one of the most important sensory organs in the human body – not just because it conveys images but because it conveys images connected with memories and emotions. So the loss of visual faculties in old age results in more than just blurred or dark images. Our entire perception of the real world around us becomes distorted. And so, therefore, does the way we interpret and assess it.

## Structure of the eye

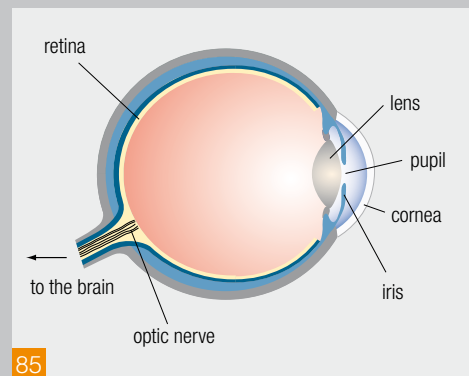

The human eye [85] works much like a camera. Light entering it is focused by the cornea and lens and falls on the retina at the back of the eye. There, specialised receptors turn the incoming light signals into biological information, which is transmitted to the brain by the optic nerve. In the brain, the signals are processed and turned into images in the visual cortex. In old age, visual performance gradually decreases and visual

perception is additionally impaired by eye disorders such as macular degeneration, cataracts or glaucoma.

## Veiling luminance

Veiling luminance is a form of interference that occurs when luminance produced by a light source near an observed object is superimposed on the image in the eye, reducing the sharpness of the image. Many of us have experienced this when driving at night with oncoming traffic. The brighter the light source and the closer it is to the object observed, the greater the visual interference. Veiling luminance is the yardstick used to measure luminance in backlit conditions.

## Out of synch

The biological impacts of impaired vision are at least as serious as the physical ones. Light entering the eye not only makes it possible for us to see; it also has a considerable influence on hormone balance. The circadian system – the internal clock that exists within us all – is largely synchronised by the blue content of the light registered by the eye. Increasing opacity of the lens reduces that incident light and disrupts the balance of the system. The consequences may be restless nights, tiredness during the day, even depression or aggression.

## Illuminance and light colour help

Independent studies showed years ago that a sixty-year-old needs four times as

much light as a twenty-year-old (see also Fig. 90). That increased requirement can be met by generally raising illuminance levels. The human organism is activated by the short-wave spectral content of lamps with a colour temperature over 5,300 kelvin and primed for sleep by warm white light below 3,300 kelvin. Exposure to the right light at the right time can thus stabilise the day/night rhythm of our body and improve our sleep patterns and general sense of wellbeing.

## Glare and colour rendering

To avoid compounding the problems of impaired vision, every effort should be made to reduce glare due to excessively high luminance. This is best achieved by indirect lighting. Visual comfort can also be increased by the use of light sources with good to very good colour rendering characteristics. Colours can then be accurately identified and assessed.

The limitations imposed by impaired vision in old age are certainly unpleasant for older people. The right lighting can make up for the deficiency, support circadian rhythms and promote a sense of wellbeing.

[86, 87] Age-related macular degeneration is a condition that causes a change in the retina at the point of sharpest vision (yellow spot). As it progresses, spatial orientation, recognition of faces, reading and perception of fine detail become increasingly difficult. Slow recovery from exposure to bright light, loss of contrast sensitivity and trouble discerning colours also make daily life harder.

[88, 89] Visual acuity and transmittance (the eye's permeability for light) gradually diminish with age. The biggest spectral losses are in the short-wave blue range.

[90, 91] The older we get, the higher the illuminance we need. Veiling luminance also increases with age, causing glare that interferes with vision.



86



87

Visual acuity and age

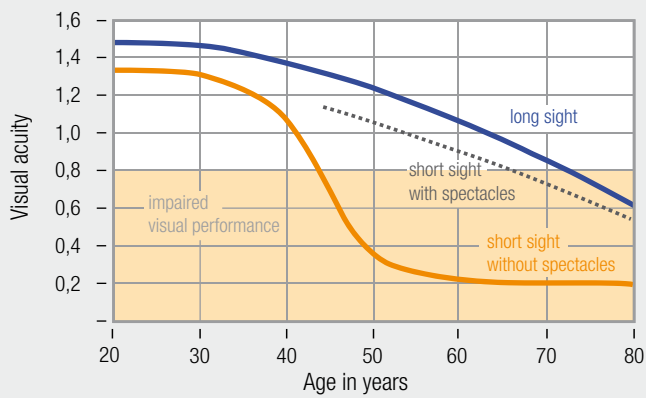

88

Spectral transmittance of the eye

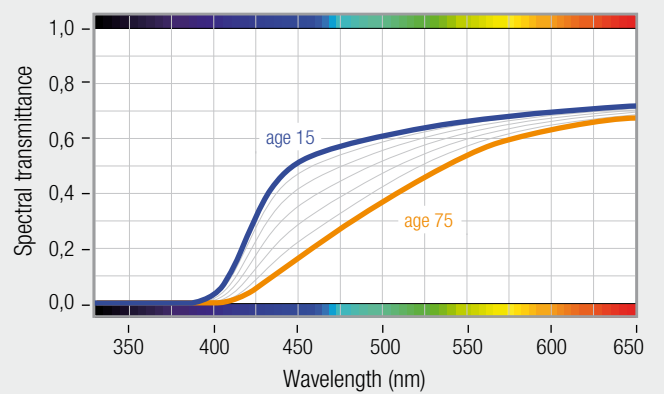

89

Increased lighting level requirements

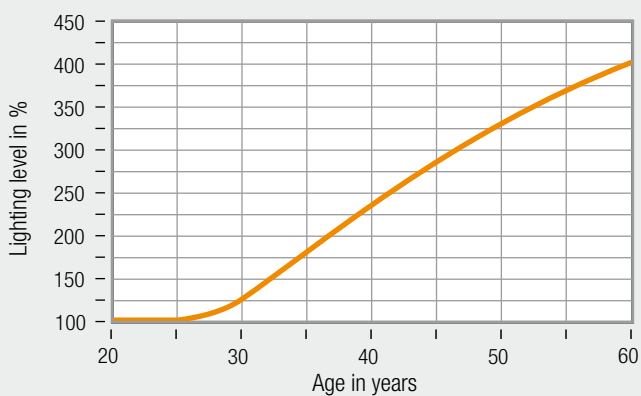

90

Increased veiling luminance in old age

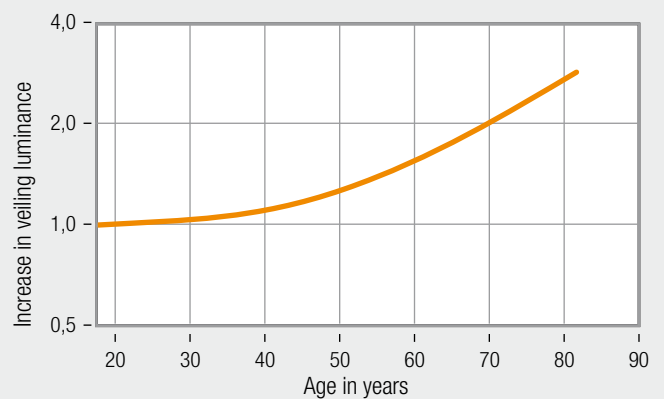

91

# Good lighting for nursing and retirement homes

Owing to demographic change, the percentage of older people – especially dementia sufferers - in society is rising. As a result, care facilities are going to play an increasingly important role as part of a responsible healthcare system.

Older people who move into a retirement home have to get used to completely new surroundings. And for many, that radical change comes at time of failing vision and physical disability. To enable them to remain as active as possible and to maintain social contacts, they should be offered a homely and agreeable environment. Good lighting plays a crucial role in shaping it.

## More light for more safety

Lighting that takes account of older people's poorer vision makes for much safer surroundings. The right lighting makes stairs, steps and uneven floors clearly visible and higher illuminance

makes faces easier to recognise. This is particularly important for dementia sufferers, who live with insecurities and fears. Uniform brightness produced by direct-indirect lighting designed to avoid glare and reflections on the floor also facilitates orientation.

## Barrier-free living space

VDI 6008 "Barrier-free buildings" presents guidelines for care services and geriatric care facilities and sets out minimum recommendations for illuminance, luminance, colour rendering and glare limitation. The following chapters look at a selection of the parameters and present some of them in tabular form.

## Wellbeing and day/night rhythm

Cheerful, stimulating light in dayrooms and social areas can create a positive atmosphere that promotes communication and interaction. What is more, residents' day/night rhythm can be significantly improved by lighting that is biologically effective. What constitutes biologically effective lighting is discussed in more detail on the following pages.

## Functionality and efficiency

Good lighting also needs to cater to the functional and operational needs of care home staff. The use of larger and/or illuminated switches can help elderly people and dementia patients find their





way around more easily. Modern lighting control systems with directly accessible lighting scenes can also make for greater comfort and convenience and at the same time save energy. Lighting installations with low maintenance, energy efficient LED luminaires can help considerably reduce operating costs in retirement and nursing homes.

[92] Ground plan of a typical care home

[93, 94] Old people need a significantly higher lighting level than young people in order to get their bearings and feel comfortable in a room.



93



94

# Communal space lighting

Communal space is where social contacts are made, meals are eaten, games are played, handicraft work is done, TV programmes are watched and special occasions are celebrated. As a multi-functional facility, it needs to offer the right light for every activity while at the same time providing a homely, comfortable lighting atmosphere for the residents.

Communal space plays a central role in nursing homes for the elderly. It is where social contact is made, where card games are played, where residents get together to watch a film. The lighting in a communal room needs to provide tailored support for a whole range of visual tasks. The general lighting should be dimmable and, for compliance with VDI guideline 6008, should deliver a minimum of 500 lux. For more demanding visual tasks such as needlework, craft work or reading, supplementary lighting should be provided to permit illuminance levels as high as 1,000 lux.

## Combined direct-indirect lighting for a homely atmosphere

Indirect lighting makes for an agreeable background brightness in the room and should be supplemented by accent lighting, which also enhances three-dimensional vision. Additional light sources such as wall or free-standing luminaires create pools of light that are slightly brighter than the background illuminance and give the room a homely atmosphere. At the same time, owing to the fact that older people's eyes are more sensitive to glare and slower to adapt, care should be taken in communal rooms to avoid the excessively marked differences in brightness that can occur, for example, as a result of highly focused beams of light and deep cast shadows.

A modern lighting concept can do far more for the residents of a retirement or care home than just provide functional lighting and a comfortable atmosphere. It can also create daylight-like light indoors and thus cater for the natural needs of older people who can rarely or never spend time outdoors. During the day, biologically effective lighting delivers bright cool-white light for activation. In the evening, it produces lower levels of warm-white light to help make for a good night's sleep. A lighting atmosphere that changes with daylight can also help dementia patients keep track of time.

Lighting that supports circadian rhythm can best be realised by large "light islands" radiating diffuse light into the room from above.

More information about the circadian effect of light is found in the chapter "Biological impact of light on human beings" on pages 18/19.

## Dynamic lighting support for a healthy sleep/wake rhythm

Biologically effective light indoors is created by varying light colour and illuminance. This supports natural phases of activity and rest, promoting a healthy day/night rhythm that helps patients be more active during the day and sleep better at night. The light colour of biologically effective light needs to range from warm white (< 3,300 kelvin) to daylight white (> 5,300 kelvin). The short-wave content of light over 5,300 kelvin has a particularly activating effect on the human body during the day. Brightness also activates. Here, it is recommended that illuminance should be raised well above the normative requirement of 200 lux. Lighting levels up to 1,600 lux are possible. In the evening, warm colour temperatures below 3,300 kelvin and a significantly lower lighting level of less than 500 lux gradually prepare the body for night.

Task or activity area (according to VDI guideline 6008)	$E_m$ Lux	UGR <sub>L</sub>	U <sub>o</sub>	R <sub>a</sub>
Day rooms	500	22	0.6	80

$E_m$ : Lux: illuminance, UGR<sub>L</sub>: glare, U<sub>o</sub>: uniformity, R<sub>a</sub>: colour rendering

[95] Indirect lighting with wall and ceiling luminaires makes for an agreeable brightness on wall and ceiling surfaces. Coloured walls facilitate orientation and ensure a cheerful atmosphere.

[96] Linear recessed luminaires with a symmetrical or asymmetrical beam are an excellent choice for highlighting architectural details. They also make for high vertical illuminance.

[97] Recessed luminaires take a back seat to architecture and permit flexible room use.



95



96



97

# Corridor and stairwell lighting

Communication routes and staircases in retirement and nursing homes connect the different parts of the building. At the same time, they are important places for interaction and communication. They require lighting solutions that facilitate orientation, underpin safety and create an agreeable sense of space.

Avoidance of accidents takes top priority in any responsible lighting design for a retirement or nursing home. Owing to the generally poorer eyesight of older people, a uniform brightness level needs to be ensured in all circulation areas. As a general rule, corridors with bright walls and ceilings look larger and make for easier orientation. According to VDI 6008, 500 lux at eye level (1.40 – 1.60m above floor level) and 200-300 lux near the floor (0.1 m above floor level) need to be provided for adequate illuminance (see also table on right). The important thing is to achieve a uniform lighting level with efficient indirect luminaires radiating light over a large area.

To avoid accidents, potential hazards need to be specially emphasised by lighting. This can be done, for example, by raising the lighting level or by installing orientation lights close to the floor. Poor visual conditions are particularly bad for dementia sufferers: dark ceilings, deep shadows and dazzling lights are often misinterpreted and can cause stress and anxiety leading to falls. For everyone's safety, staircases need to be well illuminated. Glare-free lighting and reliable recognition of the front edge of treads are absolutely essential (see also grey box on right).

## Higher efficiency, lower costs

Dark floors, walls and ceilings require higher illuminance and more energy. Where daylight is available, lighting can be lowered to the required illuminance or even deactivated by sensors and lighting control systems responding to changes in daylight.

 Safety lighting is required for all circulation areas in the building. Further information on this subject is found on page 25 and in the booklet licht.wissen 10 "Emergency Lighting, Safety Lighting".



[98] Indirect lighting makes for security and optically enlarges the room.

[99] Light defines the different zones in the room, facilitating orientation for residents and visitors.

[101] Different coloured walls help older people get their bearings in the building.

[102] Good lighting needs to ensure that stair treads are quickly and reliably recognised.



100

## Safety in circulation areas and on stairs

Circulation areas and stairs [100] in retirement and nursing homes are the arteries that connect different parts of the building. Safety is a top priority here. The luminaires used need to be well shielded and must not give rise to excessively marked differences in luminance. That would unnecessarily lengthen the time needed for eyes to adapt. Lighting with a pronounced indirect component is recommended here. Where floors are shiny, glare from reflections needs to be prevented. At staircases, well-shielded wall luminaires and minimised LED solutions that can be integrated in handrails or treads are a safety-enhancing option. Installed at the top landing, wide-angled luminaires make for short soft shadows that make treads clearly recognisable.

Task or activity area (according to VDI guideline 6008)	$\dot{E}_m$ Lux	UGR <sub>L</sub>	U <sub>o</sub>	R <sub>a</sub>
Corridors: daytime floor-level lighting (10 cm above floor level)	200-300	22	0.40	80
Corridors: day-time eye-level lighting (140-160 cm above floor level)	300-500	22	0.40	80
Corridors: night-time floor-level lighting	50-100	22	0.60	80
Stairs	300-500	22	0.40	80

$\dot{E}_m$  Lux: illuminance, UGR<sub>L</sub>: glare, U<sub>o</sub>: uniformity, R<sub>a</sub>: colour rendering



101



102

# Resident room lighting

Residents' rooms need to convey a homely, familiar atmosphere. Multiple light sources, tailored to different requirements, are hallmarks of a successful lighting concept.

A resident's room should be a place where the individual can retreat and "re-charge batteries". It is generally a highly personalised place, containing objects of special significance and items of personal furniture. For the lighting designer, the first priority needs to be functionality and homeliness.

## Multiple light sources define the space

The general lighting should deliver a minimum of 100 lux. The availability of many different light sources is regarded by residents as particularly positive. Homeliness is ensured by a mix of direct and indirect light produced by ceiling, wall, free-standing and table luminaires (for residents with dementia, free-standing luminaires should not be deployed because of the risk of accidents). Warm tone light (2,700 – 3,500 K) radiates warmth and cosiness. In addition to the functional room lighting, individual lighting scenarios and a variety of lighting moods can be realised with coloured light and an RGB control system.

## Reading and examination light

Because residents' mobility is often restricted, a flexibly adjustable reading light for 300 lux illuminance should be installed. This can also be used by nursing staff as an examination light for simple procedures. For intensive care staff, DIN 5035-3 stipulates that a high-intensity luminaire delivering a minimum of 1,000 lux should be additionally provided for examinations and nursing procedures.

## Switching and operation

For the sake of convenience, it is important that the different light sources should be easy to operate. Lighting should be swiftly and intuitively adaptable to changing requirements. This not only promotes a sense of wellbeing; it also avoids anxiety and stress situations due to uncertainty.

## Orientation lighting

Orientation lighting designed for 5 lux illuminance should be available at night, e.g. to help residents find the way to the toilet safely. To avoid unnecessarily disturbing residents who are asleep, the lights should be mounted in the lower third of the room. The presence of light at night can also prevent anxiety and disorientation, especially in the case of residents with dementia.

## Bathroom lighting

The lighting in the bathroom adjoining a resident's room should be glare- and shadow-free. This particularly applies to the mirror lighting. Large, linear luminaires at each side of the mirror or direct-indirect lighting above the mirror avoid the shadows under nose and chin that are often created by ceiling luminaires. For wide mirrors, an additional luminaire installed directly above the mirror is recommended. Warm-tone compact fluorescent lamps or LEDs behind satinised glass provide a uniform, natural light and do not dazzle the user.

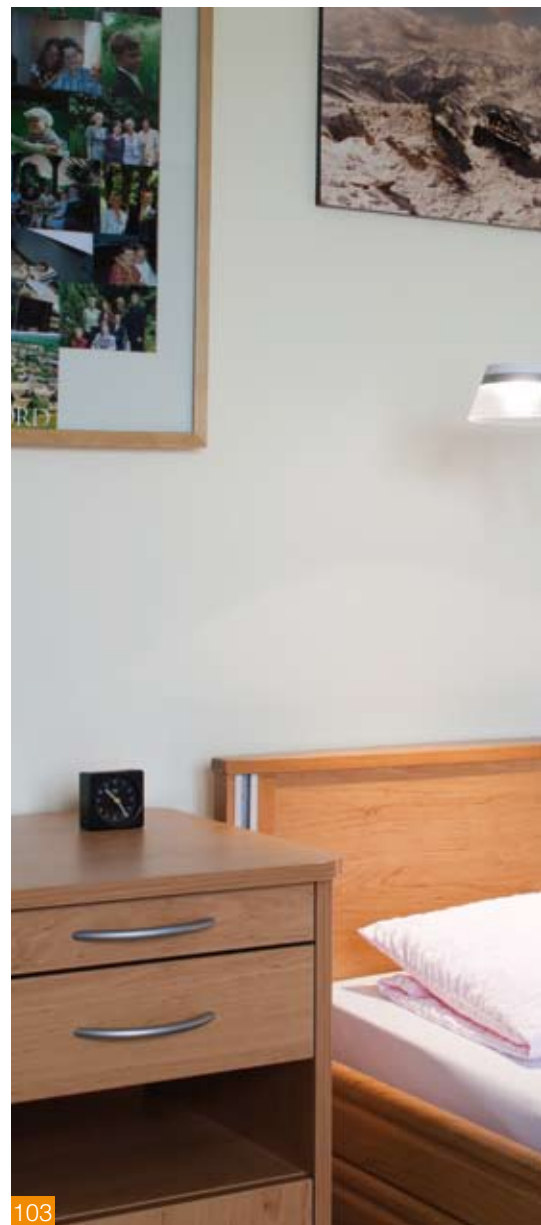

103



105

[103] The reading light beside the bed or armchair should be functional and flexibly adjustable.

[104] Good light for good sight is as important for nursing staff as it is for residents.

[105] A multifunctional luminaire can be used to provide both indirect room lighting and reading or examination light.

[106] Good lighting in an older person's bathroom makes for safety and wellbeing.



104



106



107



108



109



# LED, lighting management and daylight utilisation

Today, energy efficiency is rightly associated with technologies such as LED and modern lighting control systems. Permitting tailored lighting governed by presence detectors and light sensors, they enable optimal lighting conditions to be provided in all places at all times.

Modern luminaires increasingly incorporate LED modules, which enable costs to be cut through high energy efficiency and a long service life up to 50,000 operating hours. The industry is also working on standardisation so that older modules can be replaced by newer generations. High luminous efficacy, quality of light and longevity are guaranteed only by manufacturers of high-quality products. Thanks to long lifespans and low maintenance costs, investment in LED lighting solutions is recouped within a short space of time.

## Advantages of LED technology:

- good to very good colour rendering
- high energy efficiency
- 100% instant brightness on start-up
- long life – and thus lower maintenance costs
- variable brightness and colour temperature, e.g. for dynamic lighting
- selectable light colours and coloured light
- UV- and infrared-free beam
- robust design: impact, vibration and switching resistance
- low heat radiation – and thus lower air-conditioning costs
- disposal: no mercury content

## Lighting management for harnessing daylight

Efficient lighting technologies apart, energy can also be saved by ensuring that lighting is only activated where it is really needed. Corridors, for example, only need to be fully illuminated when persons are actually present. And a room that is flooded with light only needs artificial lighting for support in areas that are not near windows. This is where a modern lighting management system comes in, controlling each luminaire in the room to deliver only the light that is currently needed. In the case of luminaires near windows, this can cut energy requirements by up to 50%; but even for luminaires farther away, the savings can be as much as 20%.

As well as automated daylight utilisation, lighting management systems can also incorporate presence detectors that activate lights when persons enter the room. In an average German hospital, this can significantly reduce luminaire burning times and maintenance costs. But lighting management makes for more than just economy; it also offers a high degree of convenience. Maintenance operations are facilitated by the fact that spent light sources are flagged up directly on a PC. Programmed lighting scenes can also be activated to meet current requirements: activating light during the day, for example, and calming light in the evening.

[107] Properly harnessed, daylight can significantly lower energy costs in the healthcare sector.

[108, 109] Via interactive displays, modern lighting management systems offer access to programmed lighting scenes that involve all room lighting.

[110] LEDs emit light by electroluminescence when an electric current passes through them. The process generates light but also heat, which needs to be dissipated by good thermal management.

[111] Daylight-dependent lighting management systems ensure that lighting is tailored to needs. By monitoring sensors on the ceiling and at windows, they identify the quantity of light required in the room and activate, dim or deactivate luminaires accordingly.

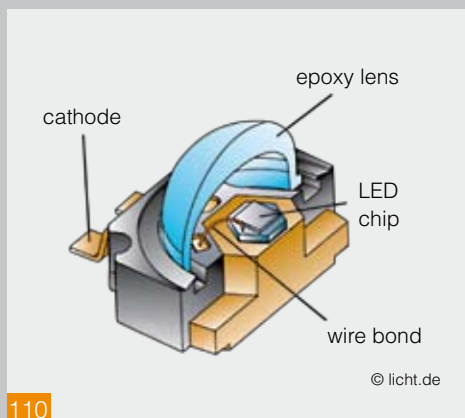

110

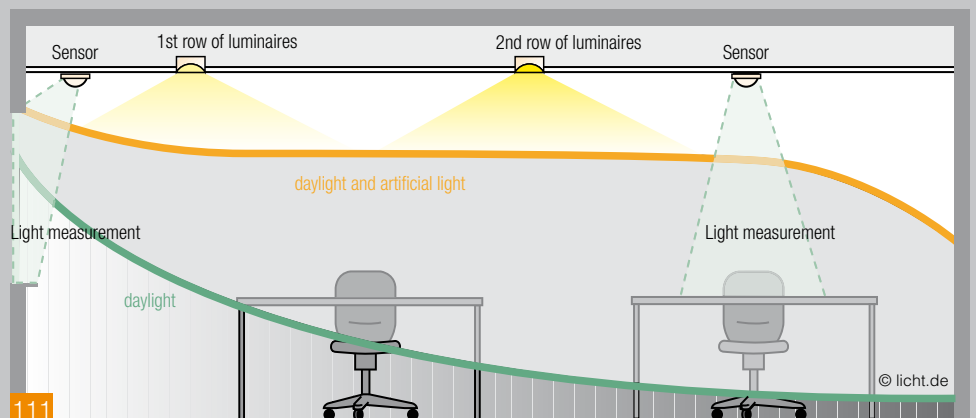

111

# Luminaires and their applications

When it comes to identifying an appropriate energy-efficient lighting solution for the diverse visual tasks performed in a healthcare facility, special attention needs to be paid to the lighting characteristics and light output ratio of luminaires and to the possibilities of integrating them in a lighting management system.

Luminaires in the healthcare sector are generally in continuous operation or in use for many hours a day. They therefore need to meet particularly high requirements in terms of quality and energy efficiency. Low maintenance is another important point to consider. High-quality luminaires incorporating LED technology are an excellent solution here. All luminaires – the term "luminaire" refers to the lighting fitment, not the lamp or light source – and components need to comply with current standards and must display the CE mark. Where lighting control systems are used, luminaires need to be dimmable. In the case of fluorescent lamps, this calls for the use of electronic ballasts, which are also significantly superior to conventional ballasts in terms of energy efficiency.

## Luminaire selection criteria

The light output ratio of a luminaire is particularly important for energy efficiency. It determines the total luminous flux radiated in the room. The higher the light output ratio, the more efficient the luminaire. The lighting characteristics of a luminaire are indicated by its intensity distribution curve (IDC). This shows the pattern of light emitted and defines the distribution of illuminance in the room.

Because of the high lighting requirements in a healthcare environment, glare limitation is an important quality feature. Optical controllers such as louvers or diffusers shield light sources from view so that glare is avoided. With diffuser luminaires, care also needs to be taken to ensure that luminance is reduced so that room occupants are not dazzled.



**Dedicated examination and surgical luminaires** provide optimal support for diagnostic or surgical procedures by ensuring extremely bright and precise illumination of the treatment plane with no glare and only minimal heat gain.



**Pendant luminaires** can be used for direct, indirect or combined direct/indirect lighting in nearly any room in the healthcare sector. They are available with different reflectors and with anti-glare louvers or diffuser panels.



**Power track systems** provide flexibility for rooms where room situations change. Luminaires and spots can be mounted on adapters at any point on the track to deliver light precisely where it is needed.

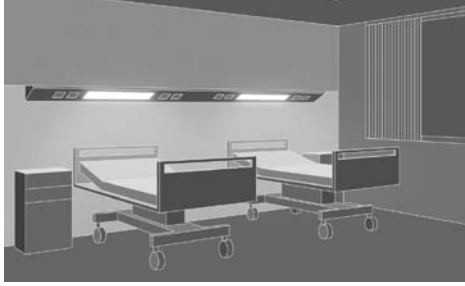

**Medical supply units with integrated lighting** provide general lighting, light for reading and examinations as well as orientation and night lighting.



**Surface-mounted and recessed ceiling luminaires** are used for general or accent lighting. They are available as models for direct or diffuse light distribution.



**Recessed panel luminaires and luminous ceilings** provide planar light and are particularly suitable for dynamically controlled, biologically effective lighting.



**Cove lights** are linear channel-shaped fittings integrated in – or mounted on – a wall or ceiling. Available in simple or moulded plaster designs, they optimally underline architecture with indirect light.



**Continuous row and lighting channel systems** are end-to-end through-wired luminaires for general lighting. Lighting channel systems can be additionally combined with high-performance spots for accent lighting.



**Wall luminaires** are often used as an element of the general lighting in corridors and stairwells. They are also suitable for decorative lighting, delivering an accentuating light that supplements the general lighting.

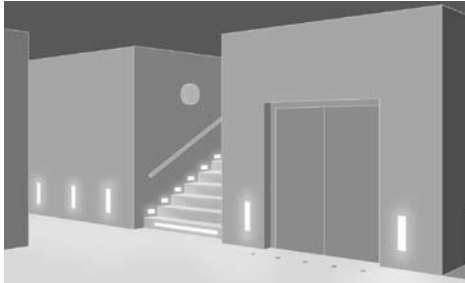

**Recessed panel luminaires and luminous ceilings** provide planar light and are particularly suitable for dynamically controlled, biologically effective lighting.



**Standalone and table luminaires** are used for non-static lighting and should be individually dimmable. Also available as models for direct-indirect lighting, they are used in surgeries, offices and resident rooms.

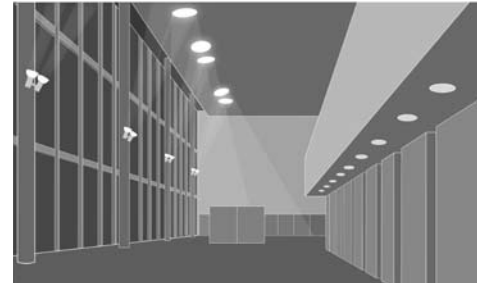

**Projector-reflector lighting systems** ensure optimal visual conditions, especially in foyers and rooms with high ceilings. A high-intensity spotlight casts light onto what is normally a slightly convex specular reflector, which distributes the light in the room according to its orientation.



**Safety luminaires** facilitate orientation in the event of a power failure and enable the building to be safely evacuated. Their operation must be independent of the mains, e.g. powered by single-use or rechargeable batteries.



**Column luminaires and light pillars** are used as technical and decorative exterior luminaires for illuminating roadways, paths and open areas. The lower the mounting height, the more luminaires are required.



**Wall luminaires, recessed ground and ceiling luminaires outdoors** are used to accentuate facades, vegetation or sculptures. They can also be used for guidance as path lighting.

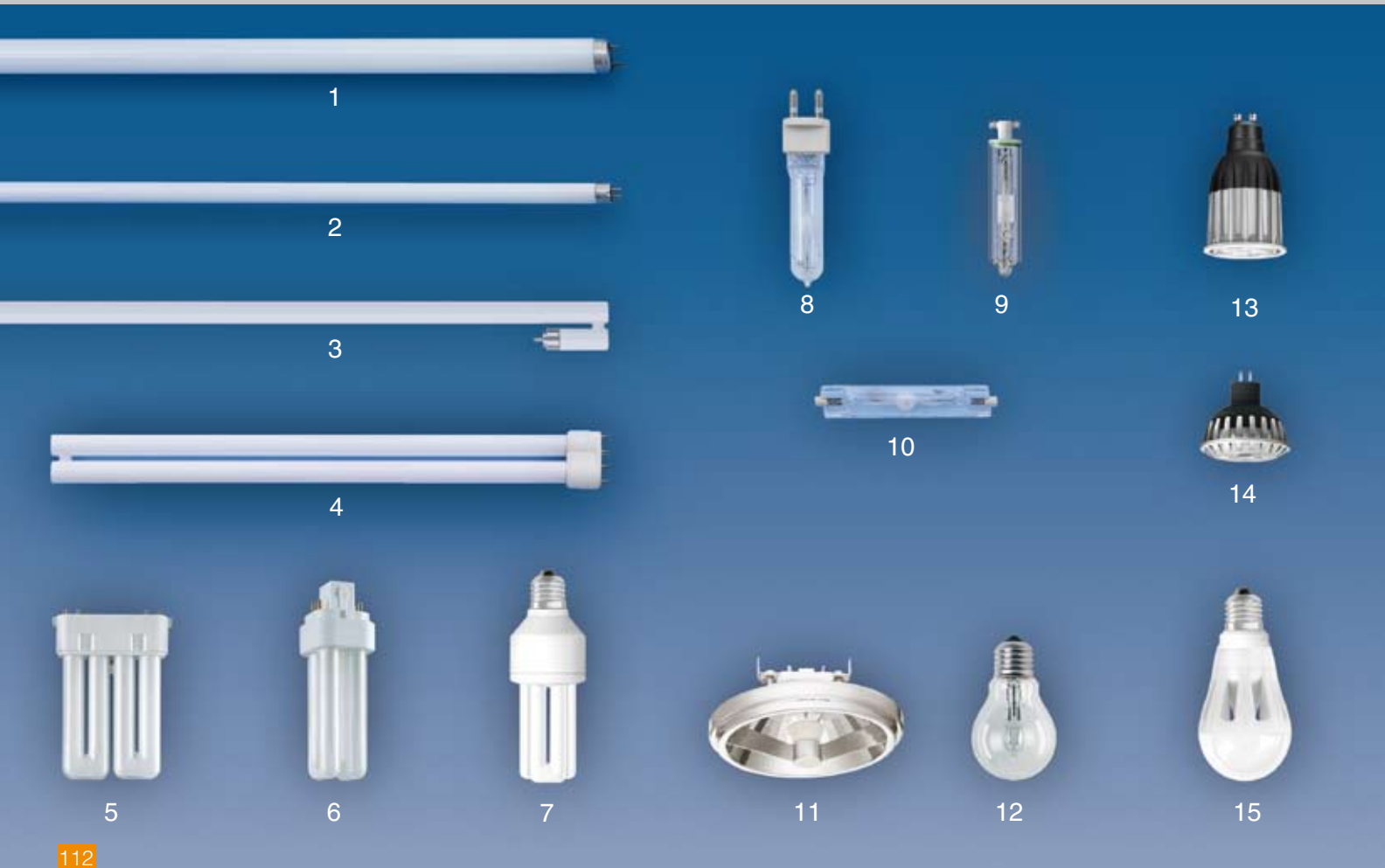

112

Nr.	Lamp type	Power rating (watt)	Luminous flux (lumen)	Luminous efficacy (lumen/watt)	Light colour
<b>Linear fluorescent lamps</b>					
1	Fluorescent lamp Ø 26 mm	18 – 70	870 – 6,200	61 – 89	ww, nw, dw
2	Fluorescent lamp Ø 16 mm	14 – 80	1,100 – 6,150**	67 – 104	ww, nw, dw
3	Fluorescent lamp Ø 16 mm	14 – 54	1,100 – 4,450**	67 – 104	ww, nw, dw
<b>Compact fluorescent lamp</b>					
4	2-tube lamp, elongated	16 – 80	950 – 6,500	67 – 100	ww, nw, dw
5	4-tube lamp, square	16 – 38	1,050 – 2,800	61 – 78	ww, nw, dw
6	1-, 2- or 3-tube lamp, compact	10 – 42	600 – 3,200	60 – 75	ww, nw, dw
7	3-tube lamp with integrated EB	8 – 30	380 – 1,940	48 – 65	ww
<b>Metal halide lamps</b>					
8	Single-ended with ceramic technology	20 – 400	1,600 – 41,000	80 – 108	ww, nw
9	Single-ended with ceramic technology	20 – 35	1,650 – 3,000	75 – 79	ww
10	Double-ended with ceramic technology	70 – 150	5,100 – 14,500	73 – 104	ww, nw
<b>Halogen lamps</b>					
11	Reflector design	10 – 100	350* – 33,000*	–	ww
12	Incandescent lamp design	18 – 105	170 – 2,000	9 – 18	ww
<b>LED lamps</b>					
13	Reflector design, line voltage	4.5 – 10	450* – 1,200*	–	ww, nw, dw
14	Reflector design, low-voltage	4.5 – 10	180 – 450	–	ww, nw, dw
15	Incandescent lamp design	2 – 12	95 – 900	45 – 75	ww, nw, dw
16	Tubular design, Ø 26 mm	11 – 30	630 – 2,600	58 – 85	ww, nw, dw
<b>LED modules</b>					
17	Rigid LED module	11 – 30	100 – 2,100	–	ww, nw
18	Flexible LED module	24.5 – 72	765 – 3,650*	31 – 50	ww, nw, dw
19	Standardised LED module	9 – 39	800 – 3,000	52 – 85	ww, nw
20	Standardised LED module	17 – 44	1,100 – 3,000	55 – 75	ww, nw

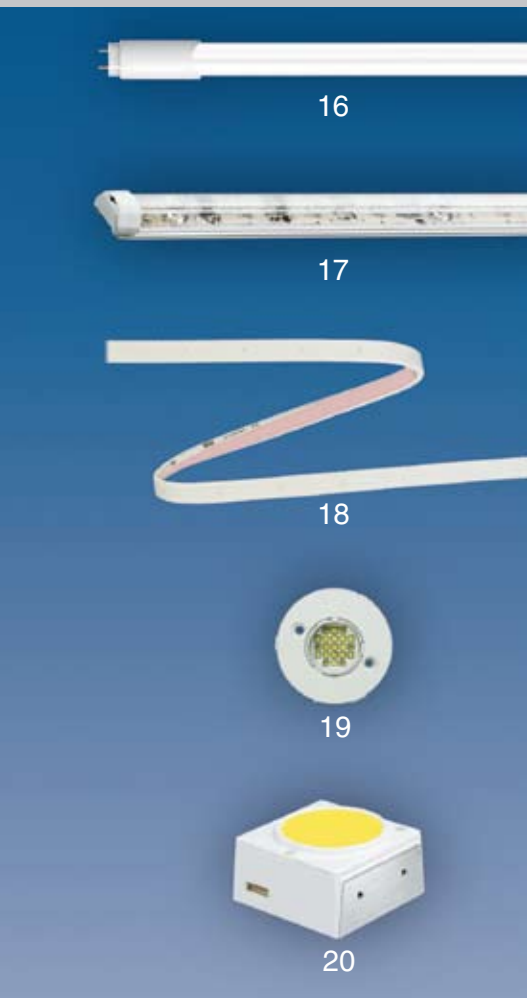

# Light sources

The right choice of light source is a prerequisite for good energy efficient lighting in the healthcare sector. These two pages show the most important types of lamp and their technical specifications.

## Fluorescent lamps [1-3]

The distinguishing features of fluorescent lamps include high luminous efficacy, good colour rendering and longevity. Operation by electronic ballast (EB) – essential in the case of 16 mm diameter lamps – improves energy efficiency and lighting quality. In addition, the life expectancy of these lamps can be extended even more by the use of warm start EBs. With appropriate EBs, fluorescent lamps can also be dimmed and used in conjunction with lighting control systems.

## Low-voltage halogen lamps [11]

Low-voltage halogen lamps are distinguished by an absolutely brilliant light with very good colour rendering properties. They need to be operated by a transformer that reduces the voltage to 12V. With appropriate transformers, they can be dimmed to any level.

## 230 V halogen lamps [12]

Because of their brilliant and agreeable light, modern energy-saving halogen lamps for mains operation are a popular choice for accent lighting, especially as reflector lamps. They can also be dimmed to any level and have very good colour rendering properties ( $R_a$  100).

## Compact fluorescent lamps [4-7]

Compact fluorescent lamps have the same characteristics as fluorescent lamps but because of their compact design can be integrated in smaller luminaires. They are also available with built-in ballasts for conventional screw lampholders (7). Recent developments have produced compact fluorescent lamps with excellent starting performance, improved switching frequency and very warm light colours (2,500K colour temperature).

## LED lamps [13-16]

Directional or diffuse, LED lamps have a life of up to 25,000 hours and are available in a wide variety of designs. Their distinguishing features include high energy efficiency, good colour rendering and diverse light colours. They also produce a beam with no UV or infrared radiation and, depending on system, are dimmable. Where they are used to replace fluorescent lamp systems (16), LED lamps change the pattern of light distribution. Electrical reliability needs to be ensured by a professional.

## Metal halide lamps [8-10]

Metal halide lamps have always been noted for their brilliant light and have become the light source of choice for attractive lighting in corridors, foyers and rooms with high ceilings. Lamps with ceramic burner technology achieve an even higher luminous efficacy, up to 100 lm/W, making them significantly more energy efficient.

## LED modules [17-20]

LED modules – consisting of LEDs and lens – now achieve a high degree of luminous efficacy and, as a result, are regarded as the solution of the future for technical and decorative lighting in educational establishments.

Colour rendering index  $R_a$   
(in some cases as range)

Base

85 – 98	G13
85 – 93	G5
80 – 90	G5
80 – 93	2G11; 2G7
80 – 90	2G10; G8R; GR10q
80 – 90	G23; G24; 2G7; GX24
80 – 90	E14; E27; B22d
80 – 85	G8,5; G12; G22
85 – 90	GU6,5; GU8,5; GY22
75 – 95	PGJ5
	RX7s; RX7s-24
100	GU4; GU5,3; G53
100	E14; E27; B22d
80 – 90	E14; E27; GU10
80 – 90	GU4; GU5,3; GU53
80 – 90	E14; E27
70 – 85	G13
70 – 80	–
80 – 89	–
80 – 95	–
80 – 90	–

\* = in candela  
\*\* = at 25°C ambient temperature

ww = warm white colour temperatures up to 3,300 K  
nw = neutral white colour temperatures 3,300 K to 5,300 K  
dw = daylight white colour temperatures 5,300 K to 6,500 K

# licht.de publications

Each Booklet!

€10,-



## licht.wissen 04 Office Lighting: Motivating and Efficient

56 pages of information from lighting professionals on all aspects of modern office lighting, from energy efficiency to refurbishment and lighting design to lighting management. Practical tips provide support for standard-compliant, energy-efficient lighting design for offices, conference rooms, corridors, foyers and outdoor facilities.



**[licht.wissen 02]** 56 pages of comprehensive information on efficient professional lighting for educational establishments. Booklet 02 also shows how good lighting can boost motivation and performance in a learning situation.



**[licht.wissen 10]** 40 pages on emergency and safety lighting. Booklet 10 provides information about standards and stipulations for the operation of emergency and safety lighting systems and explains when and where such systems need to be installed.



**[licht.wissen 17]** 60 pages of information on LEDs. Packed with practical examples, booklet 17 explains what today's LEDs can do, how they can save energy and how LED and LED module technology works.

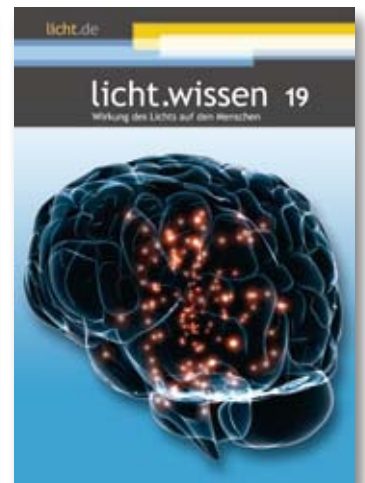

**[licht.wissen 19]** 48 pages on the biological impacts of lighting. Booklet 19 reports on the current state of research and presents practical examples showing how dynamic lighting can be realised.

licht.wissen in English – Free pdf downloads from [www.all-about-light.org/en/publications](http://www.all-about-light.org/en/publications)

- |   |  |  |
|---|--|--|
| 01 Lighting with Artificial Light (2008)                  | 08 Sport and Leisure (2010)                        | 16 City Marketing with Light (2010)                            |
| 02 Good Lighting for a Better Learning Environment (2012) | 10 Emergency Lighting, Safety Lighting (2012)      | 17 LED – The Light of the Future (2010)                        |
| 03 Roads, Paths and Squares (2007)                        | 11 Good Lighting for Hotels and Restaurants (2005) | 18 Good Lighting for Museums, Galleries and Exhibitions (2006) |
| 04 Office Lighting: Motivating and Efficient (2012)       | 12 Lighting Quality with Electronics (2003)        | 19 Impact of Light on Human Beings (2010)                      |
| 05 Industry and Trade (2009)                              | 13 Outdoor workplaces (2007)                       |  |
| 06 Shop Lighting – Attractive and Efficient (2011)        | 14 Ideas for Good Lighting for the Home (2009)     |  |
| 07 Light as a Factor in Health (2012)                     | 15 Good Outdoor Lighting for the Home (2009)       |  |

# All about light!

## Impartial information

licht.de provides information on the advantages of good lighting and offers a great deal of material on every aspect of artificial lighting and its correct usage. The information is impartial and based on current DIN standards and VDE stipulations.

## licht.wissen

The booklets 1 to 19 of the licht.wissen series provide information on the use of lighting. Themed and packed with practical examples, they explain the basics of lighting technology and present exemplary solutions. They thus facilitate cooperation with lighting and electrical specialists. The lighting information contained in all of these booklets is of a general nature.

## licht.forum

licht.forum is a compact specialist periodical focusing on topical lighting issues and trends. It is published at irregular intervals.

## www.licht.de

The industry initiative also presents its knowledge of lighting on the Internet. At [www.licht.de](http://www.licht.de), architects, designers, lighting engineers and end consumers have access to around 5,000 pages of practical tips, details of a host of lighting applications and up-to-the-minute information on light and lighting. An extensive database of product overviews provides a direct link to manufacturers.

 [www.twitter.com/licht\\_de](http://www.twitter.com/licht_de)  
[www.twitter.com/all\\_about\\_light](http://www.twitter.com/all_about_light)

 [www.facebook.com/lichtde](http://www.facebook.com/lichtde)

 [www.xing.com/companies/licht.de](http://www.xing.com/companies/licht.de)



## Impressum

### Publisher

licht.de  
Fördergemeinschaft Gutes Licht  
Lyoner Straße 9, 60528 Frankfurt am Main  
Tel. 069 6302-353, Fax 069 6302-400  
[licht.de@zvei.org](mailto:licht.de@zvei.org), [www.licht.de](http://www.licht.de)

### Editing, copywriting, design and realisation

LightAgentur, Bonn

### Copy editor

Christiane Kersting, Lüdenscheid

### Printed by

Druckhaus Haberbeck, Lage/Lippe

ISBN-Nr. 978-3-926193-83-4

12/12/00/07IV

The publication takes account of current DIN standards (available from Beuth Verlag, Berlin) and VDE stipulations (available from VDE Verlag, Berlin).

Reprints of licht.wissen 07 in full or in part only with the permission of the publishers.

### Acknowledgements for photographs

Numbering of photos on back page:

		113
114	115	116
117	118	119

### Photographs

[02] iStockphoto/Ilya Bushueve; [88, 89] Dr. Christoph Schierz, TU Ilmenau; [112] Blitzwerk, Mühlthal und LSD, Darmstadt

All other photographs, 3D visualisations and illustrations were made available by licht.de members or produced for licht.de.

# licht.wissen 07

Light as a Factor in Health



licht.de

Fördergemeinschaft Gutes Licht  
Lyoner Straße 9  
60528 Frankfurt am Main  
Germany  
phone +49 (0)69 63 02-353  
fax +49 (0)69 63 02-400  
licht.de@zvei.org  
www.licht.de